

Stomach, Intestines, Rectum
Magen, Darm, Mastdarm
Estómago, Intestino, Recto
Stomaco, Intestino, Retto

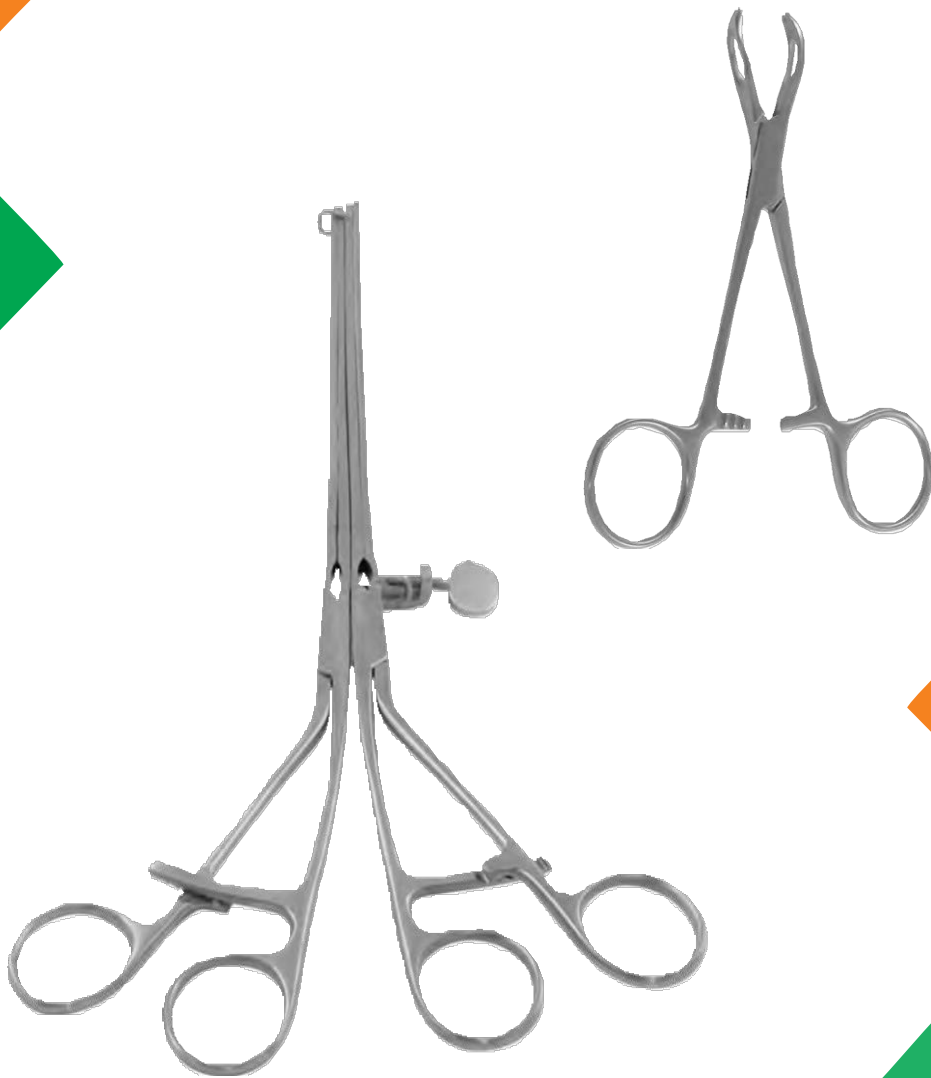

Intestinal and Tissue Grasping
Pinzas intestinales y para tejidos
Pinze da presa per intestino e tessuti
Darm-und Gewebefafzangen

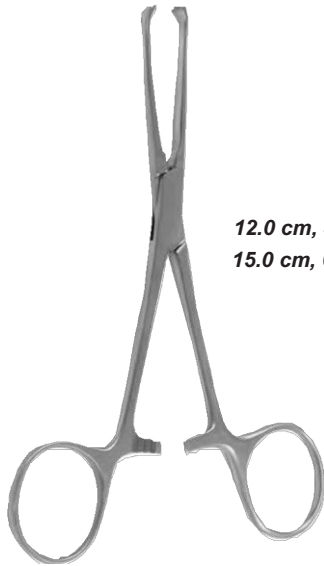

12.0 cm, 4¾" RMC-2148-12
15.0 cm, 6" RMC-2148-15

ALLIS-BABY



4 X 5

15.0 cm, 6" RMC-2149-15
19.0 cm, 7½" RMC-2149-19
25.0 cm, 9¾" RMC-2149-25

ALLIS



5 X 6

15.0 cm, 6" RMC-2150-15
19.0 cm, 7½" RMC-2150-19
25.0 cm, 9¾" RMC-2150-25

ALLIS

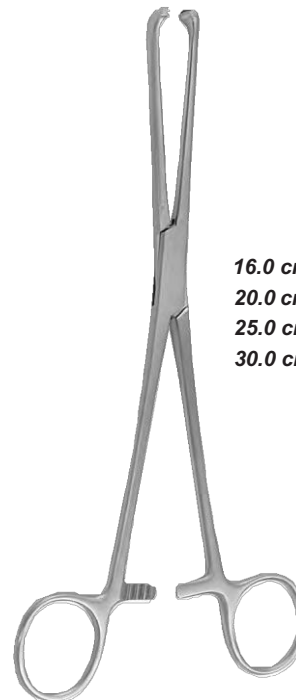

16.0 cm, 6¼" RMC-2151-15
20.0 cm, 8" RMC-2151-20
25.0 cm, 9¾" RMC-2151-25
30.0 cm, 11¼" RMC-2151-30

ALLIS-ATRAUMA

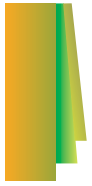

Intestinal and Tissue Grasping
Pinzas intestinales y para tejidos
Pinze da presa per intestino e tessuti
Darm-und Gewebefäßzangen



ALLEN

15.5 cm, 6" RMC-2152-15
20.0 cm, 8" RMC-2152-20
23.0 cm, 9" RMC-2152-23



1 x 2



12.5 cm, 5" RMC-2153-12
15.0 cm, 6" RMC-2153-15
19.5 cm, 7¾" RMC-2153-19

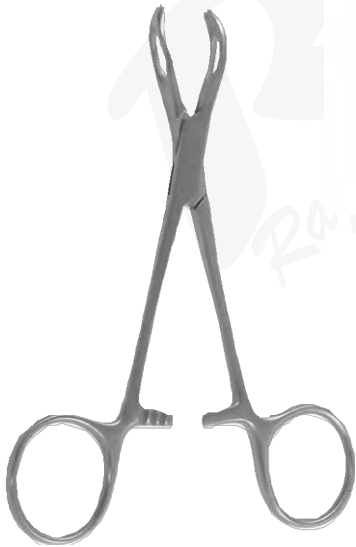

LANE



LOCKWOOD-ALLIS



16.0 cm, 6½" RMC-2154-16
20.0 cm, 8" RMC-2154-20



Intestinal and Tissue Grasping
Pinzas intestinales y para tejidos
Pinze da presa per intestino e tessuti
Darm-und Gewebefazangen



15.0 cm, 6" RMC-2155-15
19.0 cm, 7½" RMC-2155-19

JUDD-ALLIS



LITTLEWOOD
18.5 cm, 7¼"
RMC-2156-18

LITTLEWOOD



ALLIS-ADAIR
15.5 cm, 6"
RMC-2157-15

ALLIS-ADAIR



BOYS-ALLIS
15.5 cm, 6"
RMC-2158-15

BOYS-ALLIS



THOMS-ALLIS
20.0 cm, 8"
RMC-2159-20

THOMS-ALLIS



ALLIS
20.0 cm, 8"
RMC-2160-20

ALLIS

2 x 3

10 x 11

6 x 7

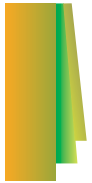

Intestinal and Tissue Grasping
Pinzas intestinales y para tejidos
Pinze da presa per intestino e tessuti
Darm-und Gewebefäßzangen

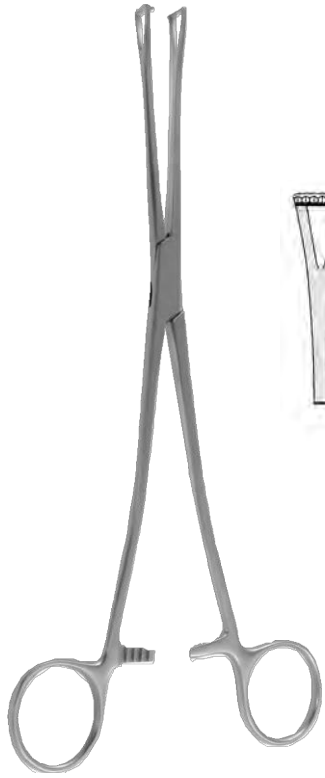

LOCKWOOD
20.0 cm, 8" RMC-2161-20



WILLIAMS
16.0 cm, 6 1/4" RMC-2162-16



BABCOCK

- 16.0 cm, 6 1/4" RMC-2163-16
- 18.0 cm, 7" RMC-2163-18
- 20.0 cm, 8" RMC-2163-20
- 24.0 cm, 9 1/2" RMC-2163-24



BABCOCK-ATRAUMA



- 16.0 cm, 6 1/4" RMC-2164-16
- 20.0 cm, 8" RMC-2164-20



BABCOCK-T C



- 16.0 cm, 6 1/4" RMC-2165-16
- 20.0 cm, 8" RMC-2165-20



DUVAL-TC
20.0 cm, 8"
RMC-2166-20

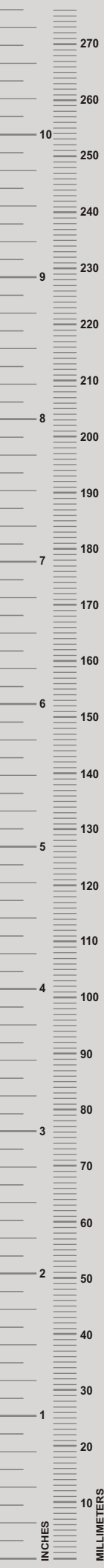

Intestinal Clamp Forceps Pinzas-clamps intestinales Pinze intestinali Darmklemmen

Darm- und Gewebefäßzangen
Intestinal and Tissue Grasping Forceps
Pinzas intestinales y para tejidos
Pinze da presa per intestino e tessuti



DUVAL

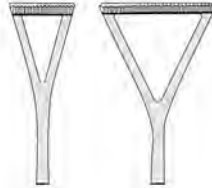

18.0 cm, 7" RMC-2167-18 RMC-2168-18
20.0 cm, 8" RMC-2167-20 RMC-2168-20
23.0 cm, 9" RMC-2167-23 RMC-2168-23

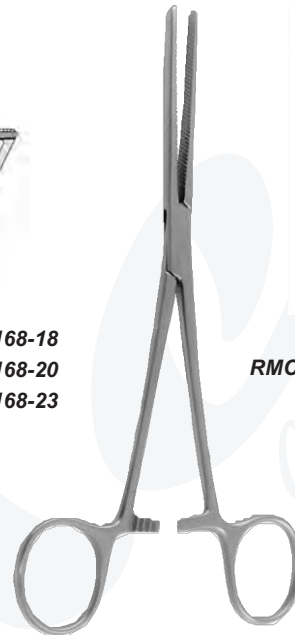

BABY-DOYEN
18.0 cm, 7"

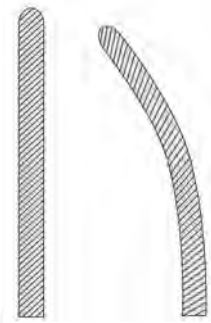

STR RMC-2169-18
CVD RMC-2170-18



DOYEN



STR

21.0 cm, 8¼" RMC-2171-21
23.0 cm, 9" RMC-2171-23

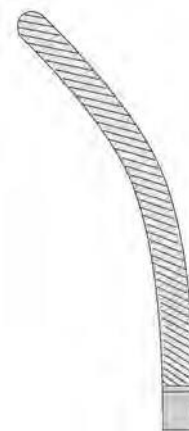

CVD

21.0 cm, 8¼" RMC-2172-21
23.0 cm, 9" RMC-2172-23

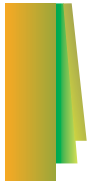

Intestinal Clamp Forceps
Pinzas-clamps intestinales
Pinze intestinali
Darmklemmen

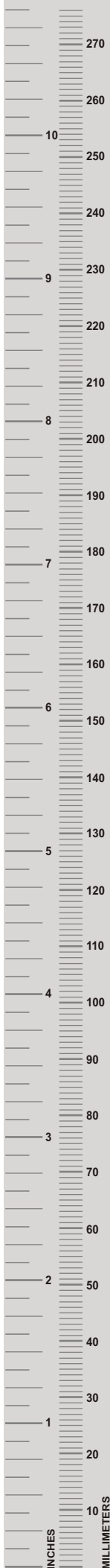

mit atraumatischer Zahnung
with atraumatic serration
con bacos atraumáticas
con morsi atraumatici

DOYEN INTESTINAL

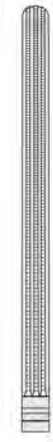

STR

21.0 cm, 8 $\frac{1}{4}$ " RMC-2173-21
23.0 cm, 9" RMC-2173-23

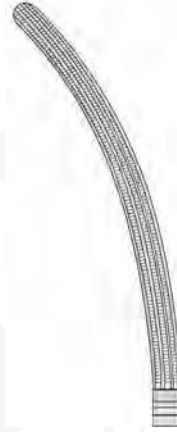

CVD

21.0 cm, 8 $\frac{1}{4}$ " RMC-2174-21
23.0 cm, 9" RMC-2174-23



KOCHER INTESTINAL



STR

22.0 cm, 8 $\frac{5}{8}$ " RMC-2175-22
25.0 cm, 9 $\frac{3}{4}$ " RMC-2175-25
28.0 cm, 11" RMC-2175-28



CVD

22.0 cm, 8 $\frac{5}{8}$ " RMC-2176-22
25.0 cm, 9 $\frac{3}{4}$ " RMC-2176-25
28.0 cm, 11" RMC-2176-28

Intestinal Clamp Forceps Pinzas-clamps intestinales Pinze intestinali Darmklemmen



mit atraumatischer Zahnung
with atraumatic serration
con bacos atraumáticos
con morsi atraumatici

KOCHER INTESTINAL

STR

22.0 cm, 8 $\frac{5}{8}$ " RMC-2177-22
25.0 cm, 9 $\frac{3}{4}$ " RMC-2177-25
28.0 cm, 11" RMC-2177-28

CVD

22.0 cm, 8 $\frac{5}{8}$ " RMC-2178-22
25.0 cm, 9 $\frac{3}{4}$ " RMC-2178-25
28.0 cm, 11" RMC-2178-28



MAYO-ROBSON INTESTINAL

STR

21.0 cm, 8 $\frac{1}{4}$ " RMC-2179-21
23.0 cm, 9" RMC-2179-23
25.0 cm, 9 $\frac{3}{4}$ " RMC-2179-25

CVD

21.0 cm, 8 $\frac{1}{4}$ " RMC-2180-21
23.0 cm, 9" RMC-2180-23
25.0 cm, 9 $\frac{3}{4}$ " RMC-2180-25

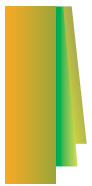

Intestinal Clamp Forceps
Pinzas-clamps intestinales
Pinze intestinali
Darmklemmen

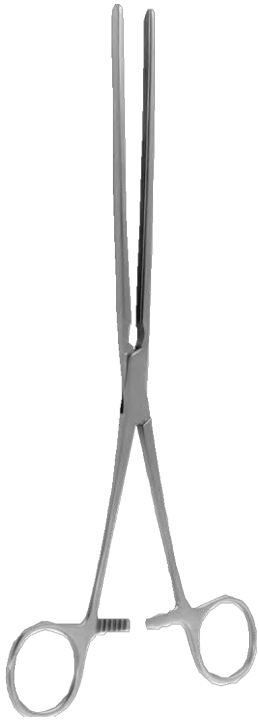

MAYO-ROBSON

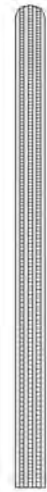

STR

21.0 cm, 8¼" RMC-2181-21
23.0 cm, 9" RMC-2181-23
25.0 cm, 9¾" RMC-2181-25

mit atraumatischer Zahnung
with atraumatic serration
con bacos atraumáticos
con morsi atraumatici



CVD

21.0 cm, 8¼" RMC-2182-21
23.0 cm, 9" RMC-2182-23
25.0 cm, 9¾" RMC-2182-25



BRUNNER

24.0 cm, 9½"
RMC-2183-24

mit atraumatischer Zahnung
with atraumatic serration
con bacos atraumáticos
con morsi atraumatici

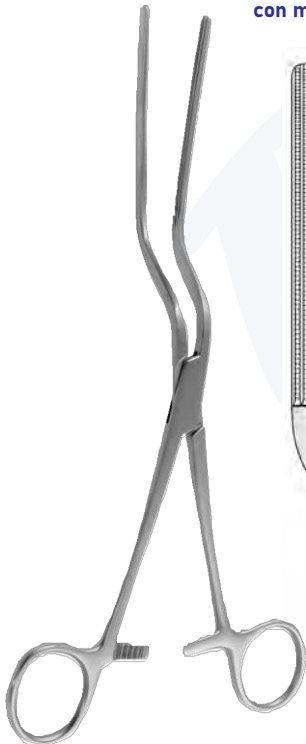

BRUNNER
24.0 cm, 9½"
RMC-2184-24

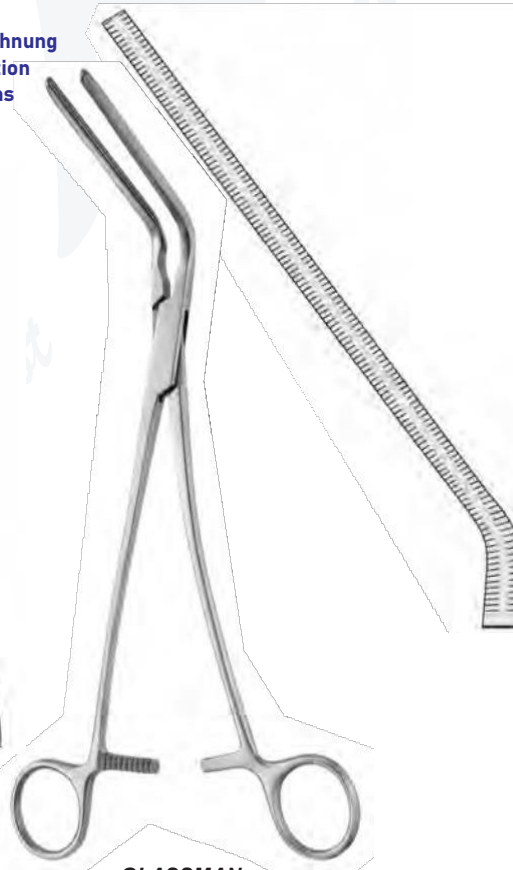

GLASSMAN
23.0 cm, 9"
RMC-2185-23



GLASSMAN
23.5 cm, 9¼"
RMC-2186-23

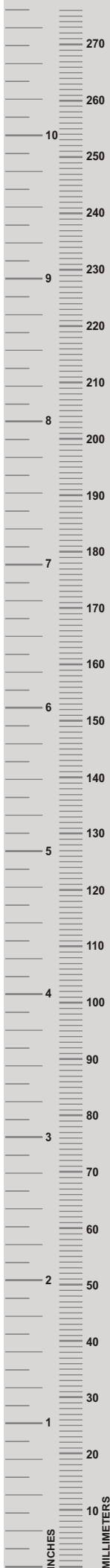

Intestinal and Stomach Clamps Pinzas-clamps intestinales y estomacales Darm-und Magenquetschklemmen Pinze/Clamp per intestino e stomac



Maullänge
length of jaws
longitud de la boca
bocche lungh

5.0 cm, 2" RMC-2187-05
7.0 cm, 2½" RMC-2187-07
10.0 cm 4" RMC-2187-10

DE MARTEL-WOLFSON



DE MARTEL-WOLFSON
8.5 cm, 3½" RMC-2188-08

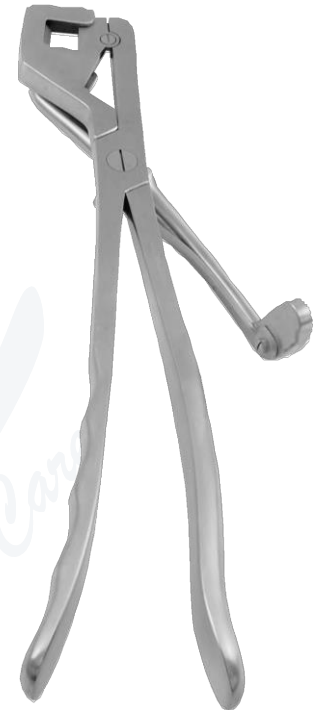

DE MARTEL-WOLFSON
26.0 cm, 10¼" RMC-2189-26

mit Stift
with pin
con espiga
con perno

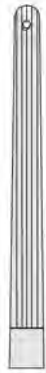

RMC-2190-25

ohne Stift
without pin
sin espiga
senza perno

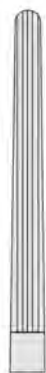

RMC-2191-25



21.0 cm, 8¼" RMC-2192-21
29.0 cm, 11½" RMC-2192-29

mit Stift
with pin
con espiga
con perno



ohne Stift
without pin
sin espiga
senza perno

RMC-2193-21
RMC-2193-29

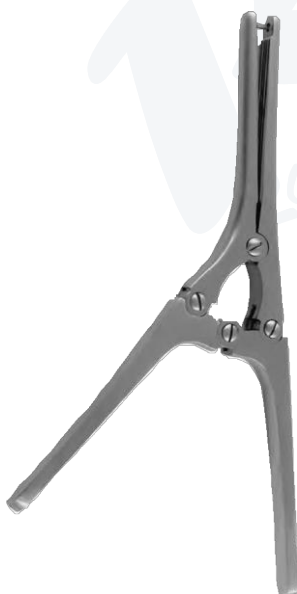

BABY-PAYR
15.0 cm, 6"

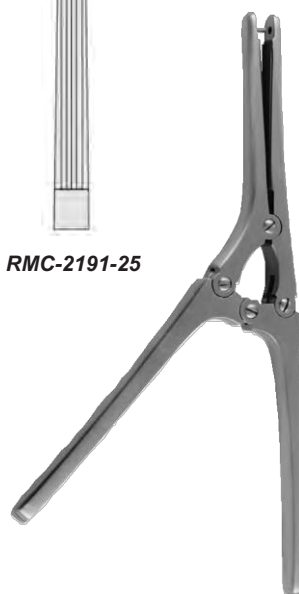

PAYR

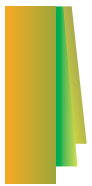

Intestinal and Stomach Clamps
Pinzas-clamps intestinales y estomacales
Darm-und Magenquetschklemmen
Pinze/Clamp per intestino e stomac

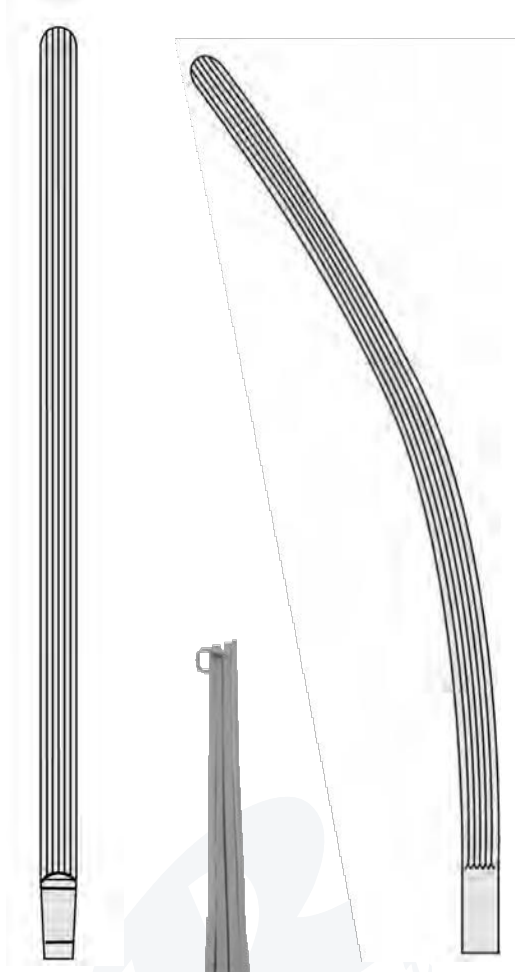

STR
RMC-2194-30

CVD
RMC-2195-30

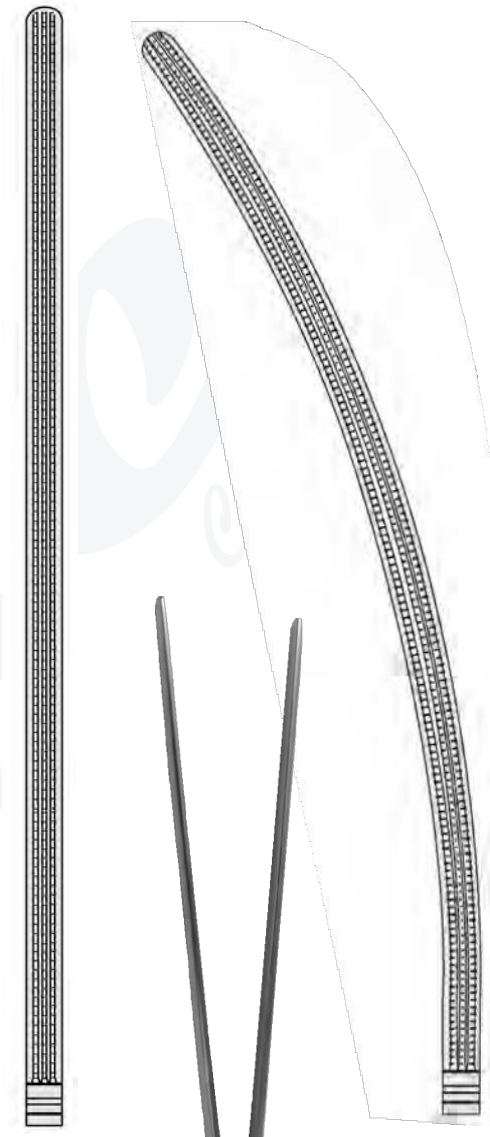

STR
RMC-2196-33

CVD
RMC-2197-33

mit atraumatischer Zahnung
with atraumatic serration
con bacos atraumáticas
con morsi atraumatici

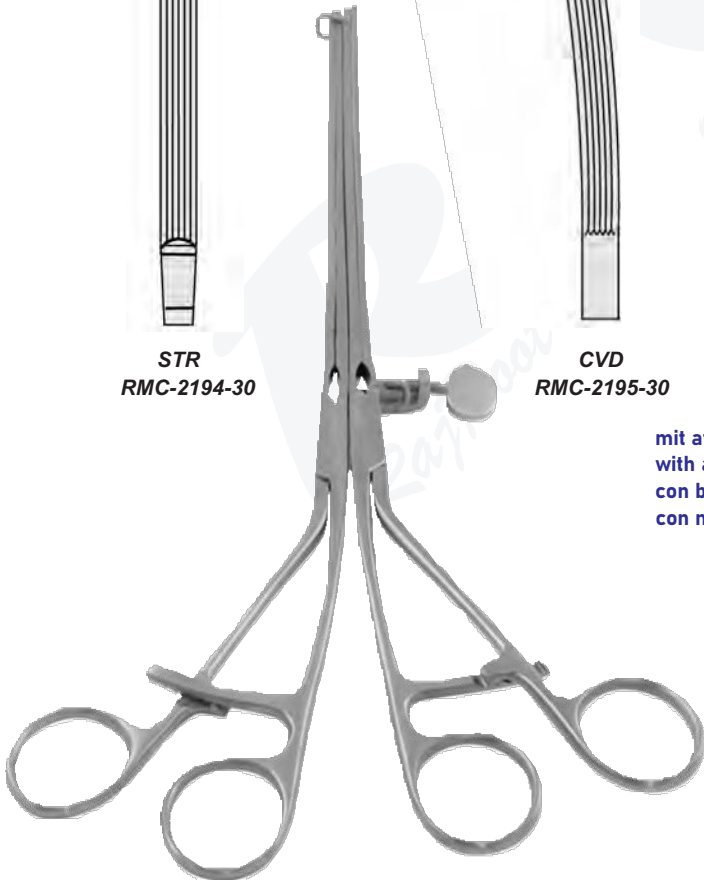

LANE
30.0 cm, 11¾"

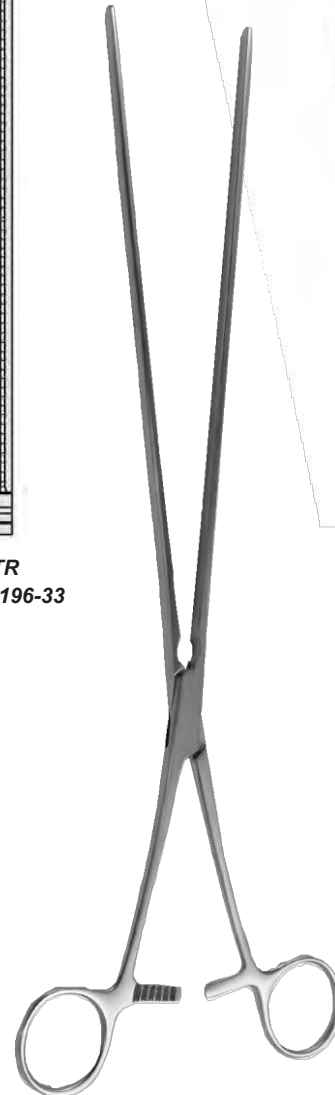

SCUDDER
33.0 cm, 13"

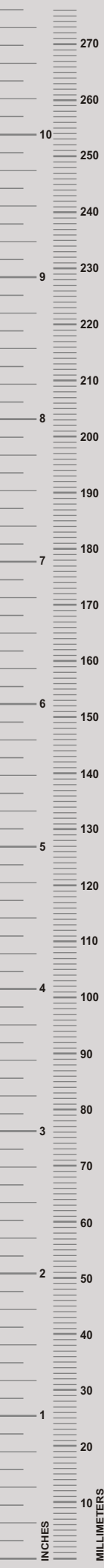

**Sigmoid Anastomosis Forceps
Rektum-Anastomosenklemmen
Pinzas para anastomosis de recto
Pinze per anastomosi de retto**



MIKULICZ
19.0 cm, 7½"
RMC-2198-19

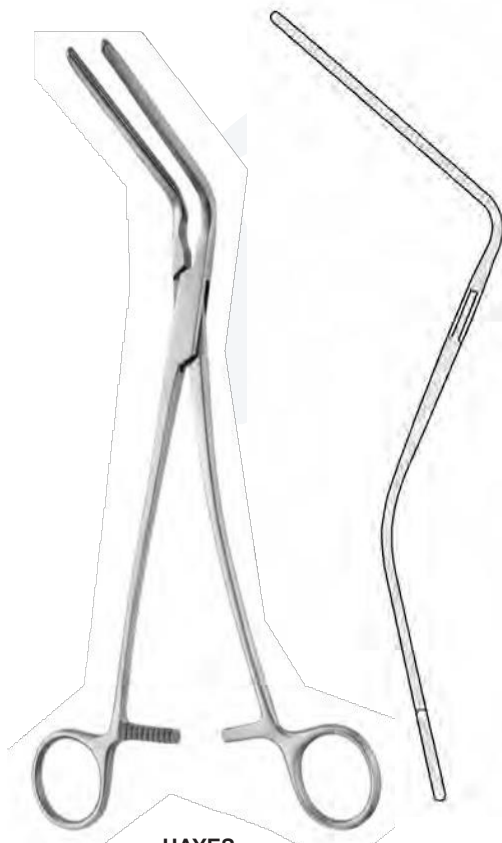
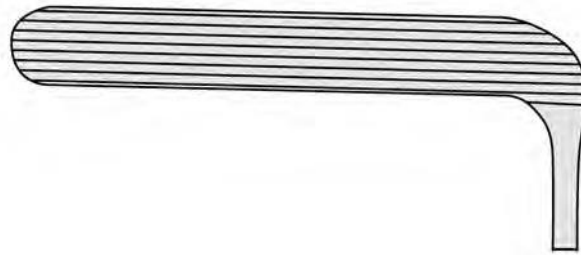

HAYES

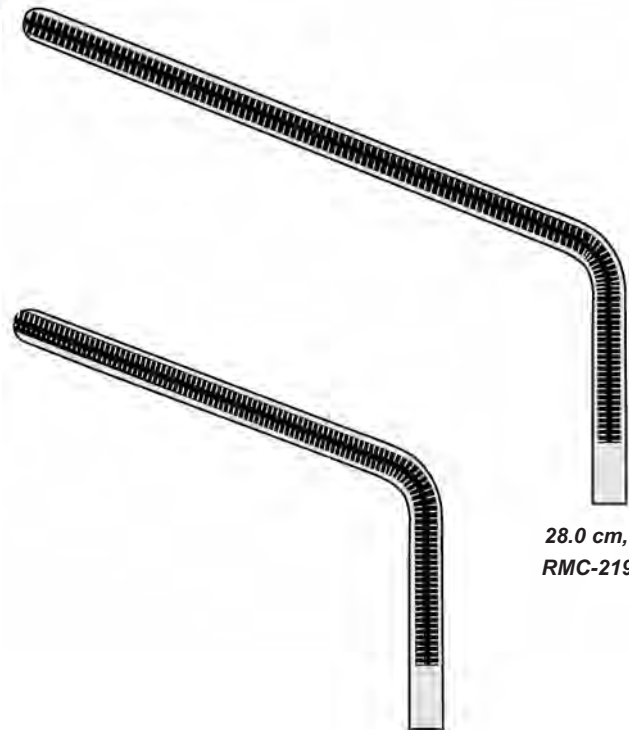

28.0 cm, 11"
RMC-2199-11

26.0 cm, 10"
RMC-2199-10

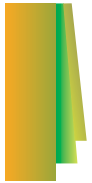

Rectal Specula
Espéculos para el recto
Mastdarm-Rektum-Spekula
Speculi rettali

17 x 89 mm



SIMS
15.0 cm, 6"
RMC-2200-15



SIMS
15.0 cm, 6"
RMC-2201-15

25 x 89 mm



MATHIEU
21.0 cm, 8 1/4"
RMC-2202-21

75 x 23 mm

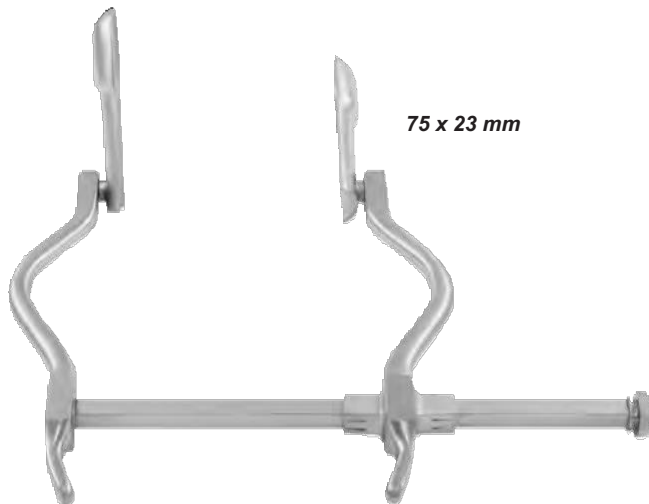

SMITH-BUIE
15.0 cm, 6"
RMC-2203-15

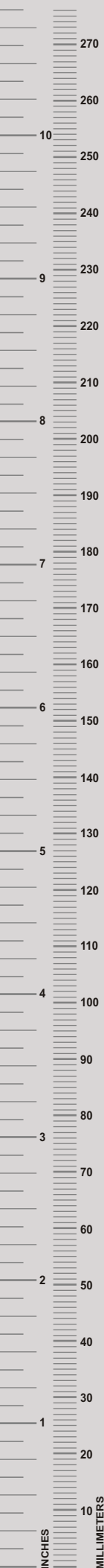

22 x 75 mm
RMC-2204-02

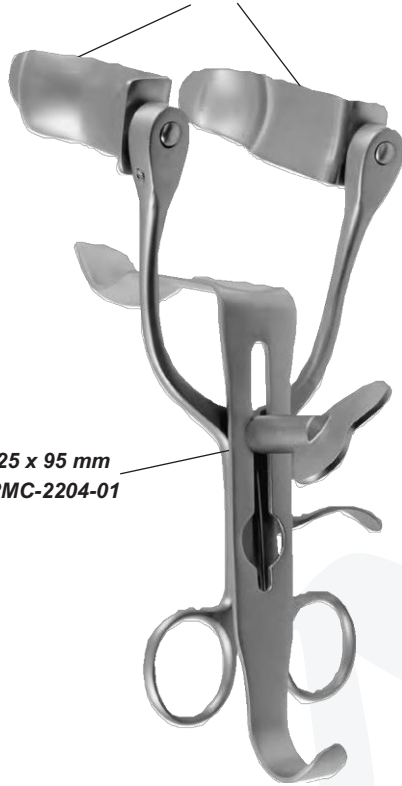

25 x 95 mm
RMC-2204-01

22 x 95 mm
RMC-2204-03



ALAN PARKS
13.5 cm, 5 5/8"
RMC-2204-00

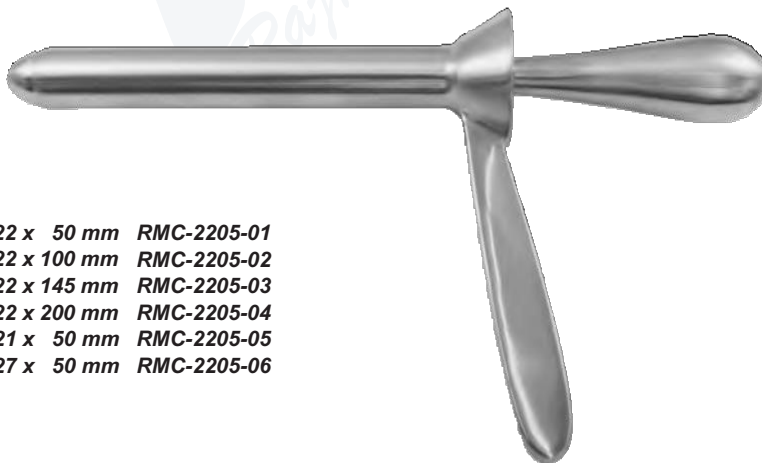

HAYES

- Ø 22 x 50 mm RMC-2205-01
- Ø 22 x 100 mm RMC-2205-02
- Ø 22 x 145 mm RMC-2205-03
- Ø 22 x 200 mm RMC-2205-04
- Ø 21 x 50 mm RMC-2205-05
- Ø 27 x 50 mm RMC-2205-06

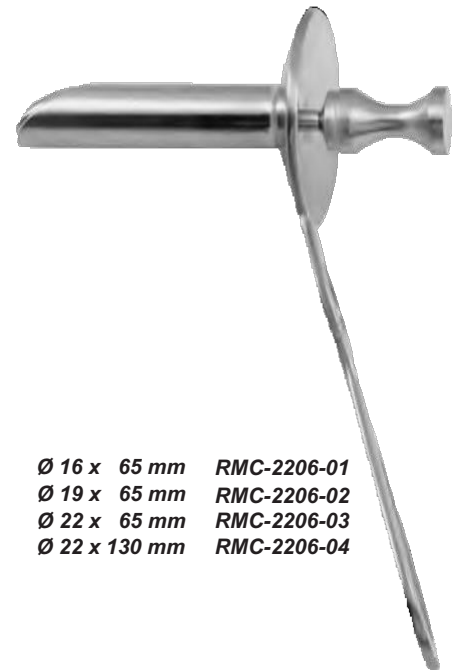

HIRSCHMANN

- Ø 16 x 65 mm RMC-2206-01
- Ø 19 x 65 mm RMC-2206-02
- Ø 22 x 65 mm RMC-2206-03
- Ø 22 x 130 mm RMC-2206-04

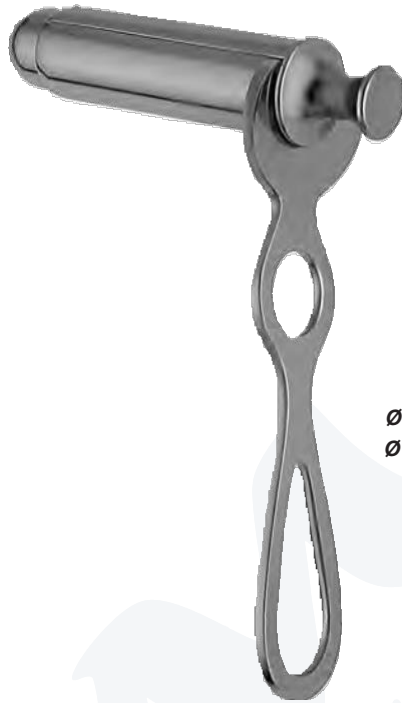
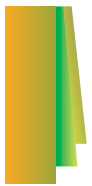

Ø 22 x 65 mm RMC-2207-22
Ø 30 x 65 mm RMC-2207-30

CHELSEA EATON



**ohne Kaltlichtträger
without cold light carrier
sin portador para luz fría
senza luce fredda**

IVES FANSLER
Ø 22 mm
RMC-2208-01

**mit Kaltlichtträger
with cold light carrier
con portador para luz fría
con luce fredda**

IVES FANSLER
Ø 22 mm
RMC-2209-02

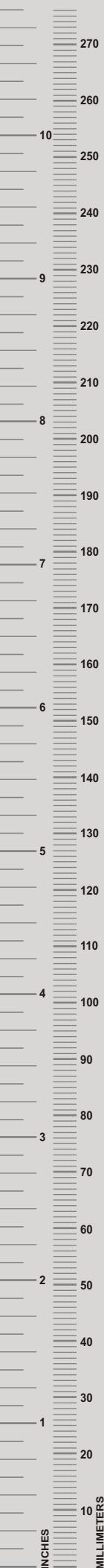

Rectal Biopsy Forceps
Mastdarm-Biopsiezangen
Pinzas sacabocado para biopsia rectal
Pinze taglienti per biopsia rettale

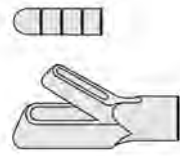

28.0 cm, 11" RMC-2210-28
 35.0 cm, 13¾" RMC-2210-35
 42.0 cm, 16½" RMC-2210-42



28.0 cm, 11" RMC-2211-28
 35.0 cm, 13¾" RMC-2211-35
 42.0 cm, 16½" RMC-2211-42

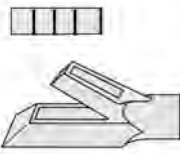

28.0 cm, 11" RMC-2212-28
 35.0 cm, 13¾" RMC-2212-35
 42.0 cm, 16½" RMC-2212-42



28.0 cm, 11" RMC-2213-28
 35.0 cm, 13¾" RMC-2213-35
 42.0 cm, 16½" RMC-2213-42



RUDD
RMC-2214



Hämorrhoiden-Ligator mit Ladekonus
Haemorrhoidal ligator with loading attachment
Ligador para hemorroides con cono de carga
Legatori emorroidali con carica a cono

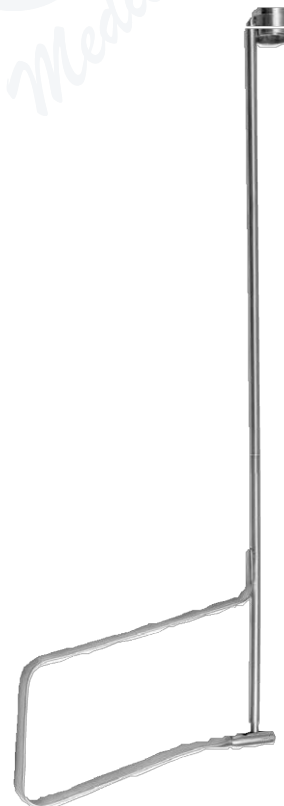

MC GIVNEY
RMC-2215

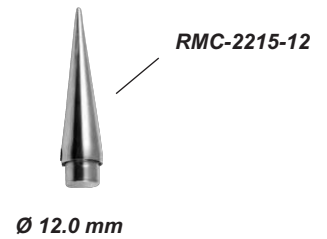

Hämorrhoiden-Ligator mit Ladekonus
Haemorrhoidal ligator with loading attachment
Ligador para hemorroides con cono de carga
Legatori emorroidali con carica a cono

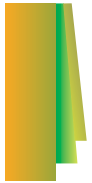

**Haemorrhoidal Forceps, Fistula probes
Hämorrhoiden-Faßzangen, Fistelsonden
Pinza-clamps para hemorroides, Sondas para fístula
Pinze per emorroidi, Sonde per fistola**

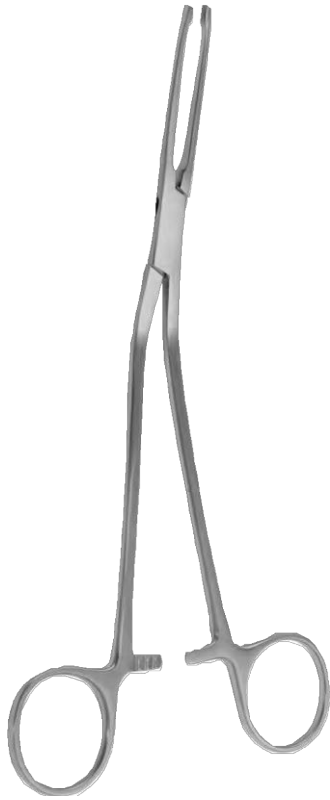

MC GIVNEY
19.0 cm, 7 1/2"
RMC-2216-19



MC GIVNEY
19.0 cm, 7 1/2"
RMC-2217-19



PRATT
21.0 cm, 8 1/4" RMC-2218-21



RMC-2218-01



RMC-2218-02



RMC-2218-03

