

**Scissors**  
**Tijeras**  
**Forbici**  
**Scheren**





**STANDARD-STR-B/B**

10.5 cm, 4 <sup>1</sup> / <sub>4</sub> "	RMC-1033-10
11.5 cm, 4 <sup>1</sup> / <sub>2</sub> "	RMC-1033-11
13.0 cm, 5"	RMC-1033-13
14.5 cm, 5 <sup>3</sup> / <sub>4</sub> "	RMC-1033-14
15.5 cm, 6"	RMC-1033-15
16.5 cm, 6 <sup>1</sup> / <sub>2</sub> "	RMC-1033-16
17.5 cm, 6 <sup>5</sup> / <sub>8</sub> "	RMC-1033-17
18.5 cm, 7 <sup>1</sup> / <sub>4</sub> "	RMC-1033-18
20.0 cm, 8"	RMC-1033-20



**STANDARD-CVD-B/B**

10.5 cm, 4 <sup>1</sup> / <sub>4</sub> "	RMC-1034-10
11.5 cm, 4 <sup>1</sup> / <sub>2</sub> "	RMC-1034-11
13.0 cm, 5"	RMC-1034-13
14.5 cm, 5 <sup>3</sup> / <sub>4</sub> "	RMC-1034-14
15.5 cm, 6"	RMC-1034-15
16.5 cm, 6 <sup>1</sup> / <sub>2</sub> "	RMC-1034-16
17.5 cm, 6 <sup>5</sup> / <sub>8</sub> "	RMC-1034-17
18.5 cm, 7 <sup>1</sup> / <sub>4</sub> "	RMC-1034-18
20.0 cm, 8"	RMC-1034-20



**STANDARD-STR-S/B**

10.5 cm, 4 <sup>1</sup> / <sub>4</sub> "	RMC-1035-10
11.5 cm, 4 <sup>1</sup> / <sub>2</sub> "	RMC-1035-11
13.0 cm, 5"	RMC-1035-13
14.5 cm, 5 <sup>3</sup> / <sub>4</sub> "	RMC-1035-14
15.5 cm, 6"	RMC-1035-15
16.5 cm, 6 <sup>1</sup> / <sub>2</sub> "	RMC-1035-16
17.5 cm, 6 <sup>5</sup> / <sub>8</sub> "	RMC-1035-17
18.5 cm, 7 <sup>1</sup> / <sub>4</sub> "	RMC-1035-18
20.0 cm, 8"	RMC-1035-20



**STANDARD-CVD-S/B**

10.5 cm, 4 <sup>1</sup> / <sub>4</sub> "	RMC-1036-10
11.5 cm, 4 <sup>1</sup> / <sub>2</sub> "	RMC-1036-11
13.0 cm, 5"	RMC-1036-13
14.5 cm, 5 <sup>3</sup> / <sub>4</sub> "	RMC-1036-14
15.5 cm, 6"	RMC-1036-15
16.5 cm, 6 <sup>1</sup> / <sub>2</sub> "	RMC-1036-16
17.5 cm, 6 <sup>5</sup> / <sub>8</sub> "	RMC-1036-17
18.5 cm, 7 <sup>1</sup> / <sub>4</sub> "	RMC-1036-18
20.0 cm, 8"	RMC-1036-20





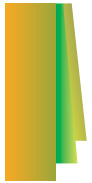

**Dissecting Scissors**  
**Präparierscheren**  
**Tijeras de disección**  
**Forbici per dissezione**

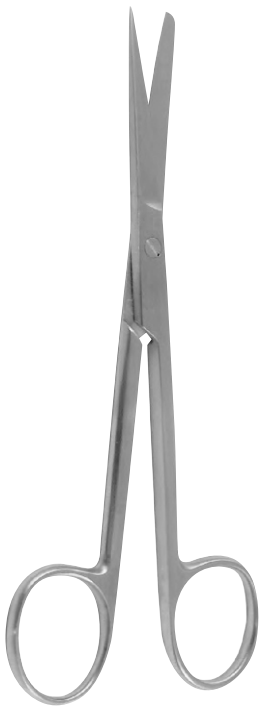

**DEAVER-STR-S/B**

12.0 cm, 4<sup>3</sup>/<sub>4</sub>" RMC-1037-12  
13.0 cm, 5" RMC-1037-13  
14.5 cm, 5<sup>3</sup>/<sub>4</sub>" RMC-1037-14

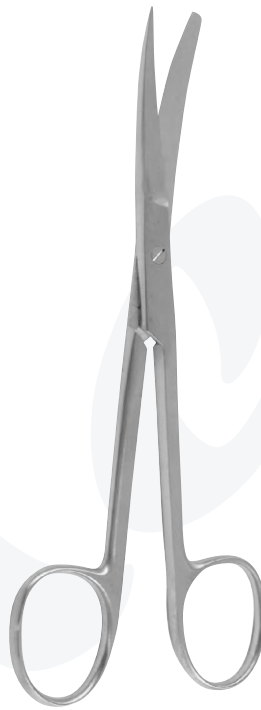

**DEAVER-CVD-S/B**

12.0 cm, 4<sup>3</sup>/<sub>4</sub>" RMC-1038-12  
13.0 cm, 5" RMC-1038-13  
14.5 cm, 5<sup>3</sup>/<sub>4</sub>" RMC-1038-14



**DEAVER-STR-S/S**

12.0 cm, 4<sup>3</sup>/<sub>4</sub>" RMC-1039-12  
13.0 cm, 5" RMC-1039-13  
14.5 cm, 5<sup>3</sup>/<sub>4</sub>" RMC-1039-14



**DEAVER-CVD-S/S**

12.0 cm, 4<sup>3</sup>/<sub>4</sub>" RMC-1040-12  
13.0 cm, 5" RMC-1040-13  
14.5 cm, 5<sup>3</sup>/<sub>4</sub>" RMC-1040-14



**Surgical Scissors, Dissecting Scissors**  
**Chirurgische Scheren, Präparierscheren**  
**Tijeras para cirugía, Tijeras de disección**  
**Forbici per chirurgia, Forbici per dissezione**



**STANDARD-STR-S/S**

- 10.5 cm, 4<sup>1</sup>/<sub>4</sub>" RMC-1041-10
- 11.5 cm, 4<sup>1</sup>/<sub>2</sub>" RMC-1041-11
- 13.0 cm, 5" RMC-1041-13
- 14.5 cm, 5<sup>3</sup>/<sub>4</sub>" RMC-1041-14
- 15.5 cm, 6" RMC-1041-15
- 16.5 cm, 6<sup>1</sup>/<sub>2</sub>" RMC-1041-16
- 17.5 cm, 6<sup>5</sup>/<sub>8</sub>" RMC-1041-17
- 18.5 cm, 7<sup>1</sup>/<sub>4</sub>" RMC-1041-18
- 20.0 cm, 8" RMC-1041-20



**STANDARD-CVD-S/S**

- 10.5 cm, 4<sup>1</sup>/<sub>4</sub>" RMC-1042-10
- 11.5 cm, 4<sup>1</sup>/<sub>2</sub>" RMC-1042-11
- 13.0 cm, 5" RMC-1042-13
- 14.5 cm, 5<sup>3</sup>/<sub>4</sub>" RMC-1042-14
- 15.5 cm, 6" RMC-1042-15
- 16.5 cm, 6<sup>1</sup>/<sub>2</sub>" RMC-1042-16
- 17.5 cm, 6<sup>5</sup>/<sub>8</sub>" RMC-1042-17
- 18.5 cm, 7<sup>1</sup>/<sub>4</sub>" RMC-1043-18
- 20.0 cm, 8" RMC-1043-20



**DEAVER-STR-B/B**

- 12.0 cm, 4<sup>3</sup>/<sub>4</sub>" RMC-1043-12
- 13.0 cm, 5" RMC-1043-13
- 14.5 cm, 5<sup>3</sup>/<sub>4</sub>" RMC-1043-14



**DEAVER-CVD-B/B**

- 12.0 cm, 4<sup>3</sup>/<sub>4</sub>" RMC-1044-12
- 13.0 cm, 5" RMC-1044-13
- 14.5 cm, 5<sup>3</sup>/<sub>4</sub>" RMC-1044-14

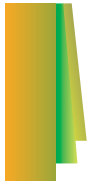

**Dissecting Scissors**  
**Präparierscheren**  
**Tijeras de disección**  
**Forbici per dissezione**



**GRAZIL-STR-B/B**

13.0 cm, 5" RMC-1045-13  
14.5 cm, 5<sup>3</sup>/<sub>4</sub>" RMC-1045-14

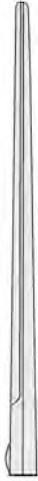

**GRAZIL-CVD-B/B**

13.0 cm, 5" RMC-1046-13  
14.5 cm, 5<sup>3</sup>/<sub>4</sub>" RMC-1046-14



**STR-S/B**

13.0 cm, 5" RMC-1047-13  
14.5 cm, 5<sup>3</sup>/<sub>4</sub>" RMC-1047-14

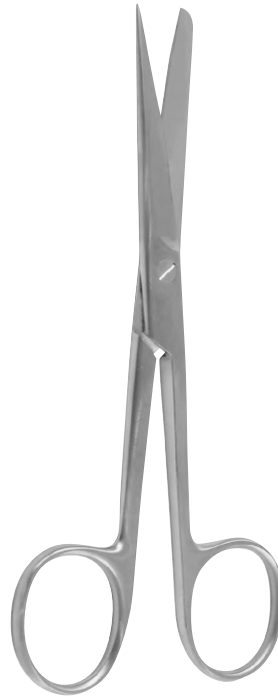

**CVD-S/B**

13.0 cm, 5" RMC-1048-14  
14.5 cm, 5<sup>3</sup>/<sub>4</sub>" RMC-1048-14



**GRAZIL**

**GRAZIL**



**Dissecting Scissors**  
**Präparierscheren**  
**Tijeras de disección**  
**Forbici per dissezione**



**GRAZIL-STR-S/S**  
13.0 cm, 5" RMC-1049-13  
14.5 cm, 5<sup>3</sup>/<sub>4</sub>" RMC-1049-14



**GRAZIL-CVD-S/S**  
13.0 cm, 5" RMC-1050-13  
14.5 cm, 5<sup>3</sup>/<sub>4</sub>" RMC-1050-14



**MAYO-STR-B/B**  
14.5 cm, 5<sup>3</sup>/<sub>4</sub>" RMC-1051-14  
17.0 cm, 6<sup>3</sup>/<sub>4</sub>" RMC-1051-17  
23.0 cm, 9" RMC-1051-23  
28.0 cm, 11" RMC-1051-28

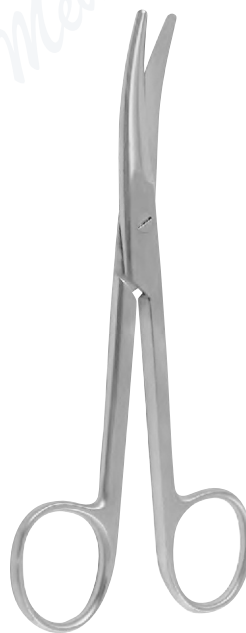

**MAYO-CVD-B/B**  
14.5 cm, 5<sup>3</sup>/<sub>4</sub>" RMC-1052-14  
17.0 cm, 6<sup>3</sup>/<sub>4</sub>" RMC-1052-17  
23.0 cm, 9" RMC-1052-23  
28.0 cm, 11" RMC-1052-28



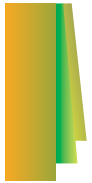

**Dissecting Scissors**  
**Präparierscheren**  
**Tijeras de disección**  
**Forbici per dissezione**



**MAYO-STILE-STR-B/B**

- 15.0 cm, 6" **RMC-1053-15**
- 17.0 cm, 6<sup>3</sup>/<sub>4</sub>" **RMC-1053-17**
- 19.5 cm, 7<sup>3</sup>/<sub>4</sub>" **RMC-1053-19**
- 21.0 cm, 8<sup>1</sup>/<sub>4</sub>" **RMC-1053-21**



**MAYO-STILE-CVD-B/B**

- 15.0 cm, 6" **RMC-1054-15**
- 17.0 cm, 6<sup>3</sup>/<sub>4</sub>" **RMC-1054-17**
- 19.5 cm, 7<sup>3</sup>/<sub>4</sub>" **RMC-1054-19**
- 21.0 cm, 8<sup>1</sup>/<sub>4</sub>" **RMC-1054-21**



**MAYO-NOBLE**  
17.0 cm, 6<sup>3</sup>/<sub>4</sub>"



**STR-B/B**  
**RMC-1055-17**



**CVD-B/B**  
**RMC-1056-17**



**FOMON**  
13.5 cm, 5<sup>3</sup>/<sub>8</sub>"



**ANGULAR**  
**RMC-1057-13**



**Dissecting Scissors**  
Tijeras de disección  
Forbici per dissezione  
Präparierscheren



**BABY-METZENBAUM**  
11.5 cm, 4½"

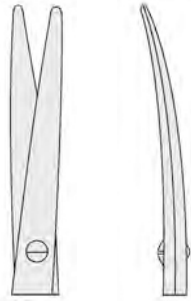

**CVD-B/B**  
RMC-1058-11 RMC-1059-11



**METZENBAUM**  
14.5 cm, 5¾"

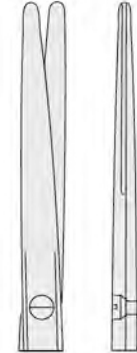

**STR-B/B**  
RMC-1060-11

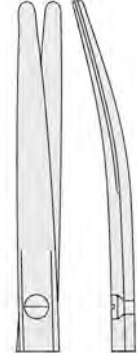

**CVD-B/B**  
RMC-1061-14



**METZENBAUM**  
14.5 cm, 5¾"  
RMC-1062-14

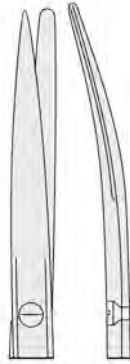

**CVD-S/B**



**METZENBAUM-CVD-S/S**  
14.5 cm, 5¾"  
RMC-1063-14



**CVD-S/S**

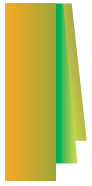

**Dissecting Scissors  
Präparierscheren  
Tijeras de disección  
Forbici per dissezione**

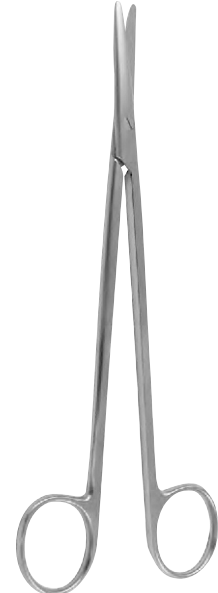

**METZENBAUM**

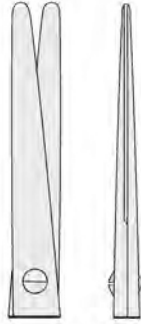

**STR-B/B**

- 18.0 cm, 7" RMC-1064-18
- 20.0 cm, 8" RMC-1064-20
- 23.0 cm, 9" RMC-1064-23
- 25.0 cm, 10" RMC-1064-25
- 28.0 cm, 11" RMC-1064-28
- 30.0 cm, 12" RMC-1064-30

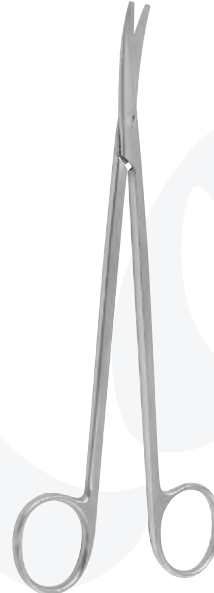

**METZENBAUM**



**CVD-B/B**

- 18.0 cm, 7" RMC-1065-18
- 20.0 cm, 8" RMC-1065-20
- 23.0 cm, 9" RMC-1065-23
- 25.0 cm, 10" RMC-1065-25
- 28.0 cm, 11" RMC-1065-28
- 30.0 cm, 12" RMC-1065-30



**METZENBAUM**

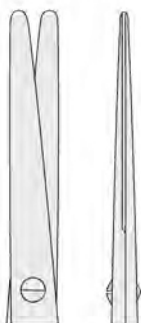

**STR-S/B**

- 18.0 cm, 7" RMC-1066-18
- 20.0 cm, 8" RMC-1066-20
- 23.0 cm, 9" RMC-1066-23
- 25.0 cm, 10" RMC-1066-25
- 28.0 cm, 11" RMC-1066-28
- 30.0 cm, 12" RMC-1066-30

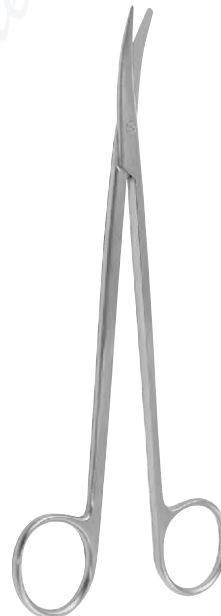

**METZENBAUM**

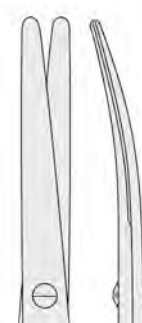

**CVD-S/B**

- 18.0 cm, 7" RMC-1067-18
- 20.0 cm, 8" RMC-1067-20
- 23.0 cm, 9" RMC-1067-23
- 25.0 cm, 10" RMC-1067-25
- 28.0 cm, 11" RMC-1067-28
- 30.0 cm, 12" RMC-1072-30





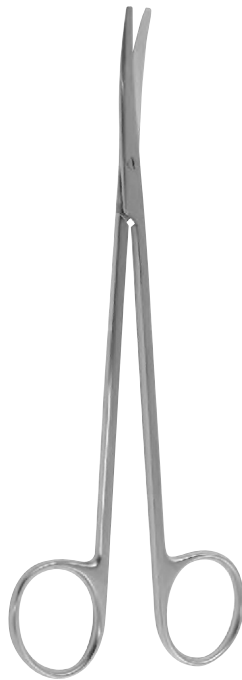

**METZENBAUM-FINO**

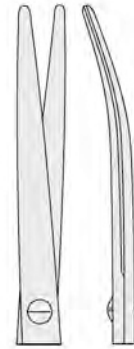

**CVD-B/B**

- 18.0 cm, 7" RMC-1068-18
- 20.0 cm, 8" RMC-1068-20
- 23.0 cm, 9" RMC-1068-23
- 25.0 cm, 10" RMC-1068-25
- 28.0 cm, 11" RMC-1068-28
- 30.0 cm, 12" RMC-1068-30

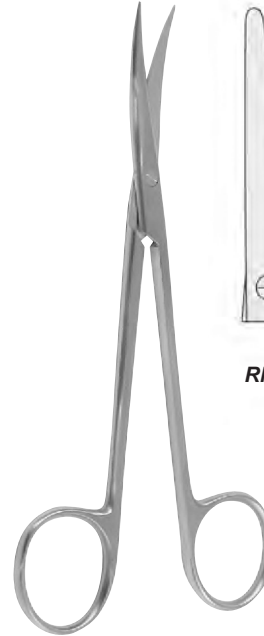

**METZENBAUM-FINO**

14.5 cm, 5 3/4"

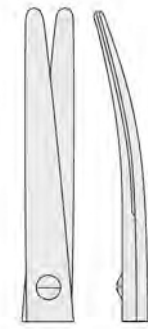

**CVD-B/B**  
RMC-1069-14

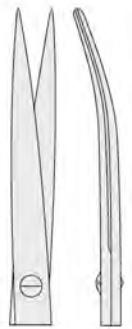

**CVD-S/S**  
RMC-1070-14



**METZENBAUM-FINO**

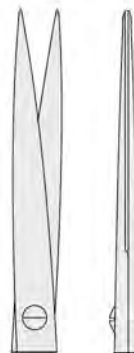

**STR-S/S**

- 18.0 cm, 7" RMC-1071-18
- 20.0 cm, 8" RMC-1071-20
- 23.0 cm, 9" RMC-1071-23
- 25.0 cm, 10" RMC-1071-25
- 28.0 cm, 11" RMC-1071-28
- 30.0 cm, 12" RMC-1071-30

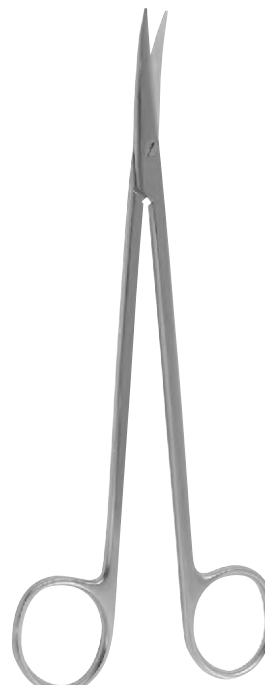

**METZENBAUM-FINO**



**CVD-S/S**

- 18.0 cm, 7" RMC-1072-18
- 20.0 cm, 8" RMC-1072-20
- 23.0 cm, 9" RMC-1072-23
- 25.0 cm, 10" RMC-1072-25
- 28.0 cm, 11" RMC-1072-28
- 30.0 cm, 12" RMC-1072-30



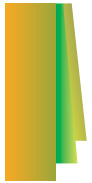

**Dissecting Scissors**  
**Tijeras de disección**  
**Forbici per dissezione**  
**Präparierscheren**

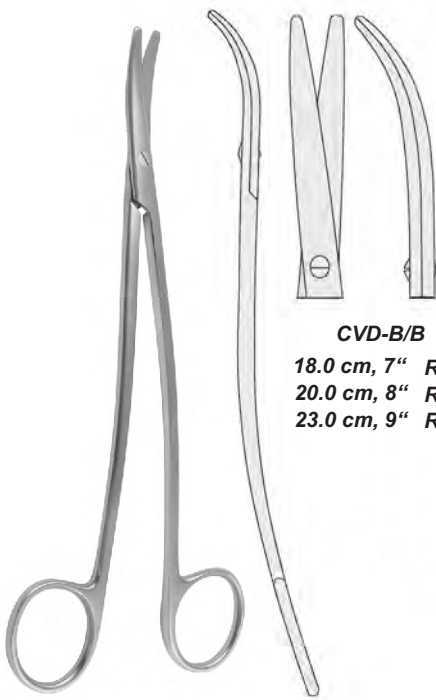

**CVD-B/B**  
18.0 cm, 7" RMC-1073-18  
20.0 cm, 8" RMC-1073-20  
23.0 cm, 9" RMC-1073-23

**METZENBAUM-FINO S-SHAPED**

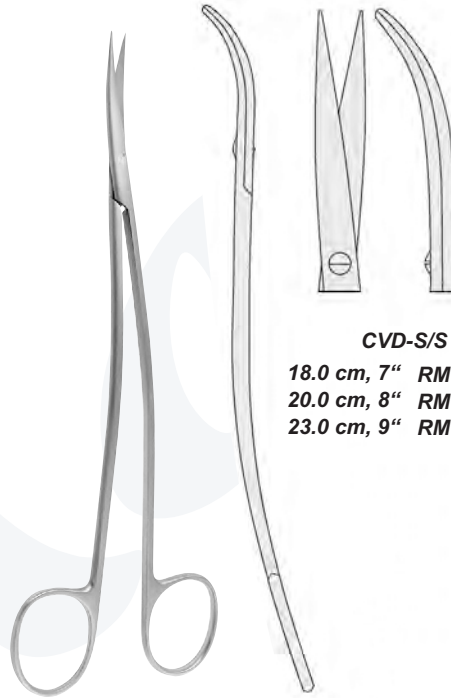

**CVD-S/S**  
18.0 cm, 7" RMC-1074-18  
20.0 cm, 8" RMC-1074-20  
23.0 cm, 9" RMC-1074-23

**METZENBAUM-FINO S-SHAPED**



**METZENBAUM-LAHEY-CVD-B/B**  
14.0 cm, 5½"  
RMC-1075-14

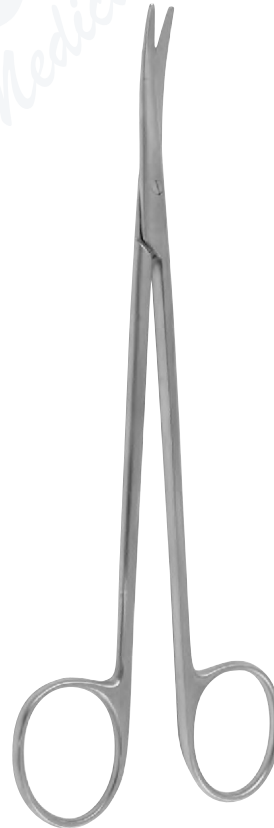

**TOENNIS-ADSON**  
17.0 cm, 6¾"

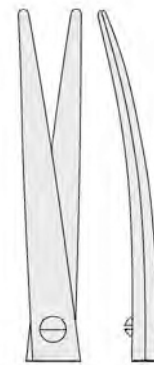

**CVD-B/B**  
RMC-1076-17



**Dissecting Scissors**  
**Präparierscheren**  
**Tijeras de disección**  
**Forbici per dissezione**



**BABY-LEXER**  
10.0 cm, 4"



**STR-B/B**  
RMC-1077-10



**CVD-B/B**  
RMC-1078-10



**LEXER**



**STR-B/B**  
16.0 cm, 6¼" RMC-1079-16  
21.0 cm, 8¼" RMC-1079-21

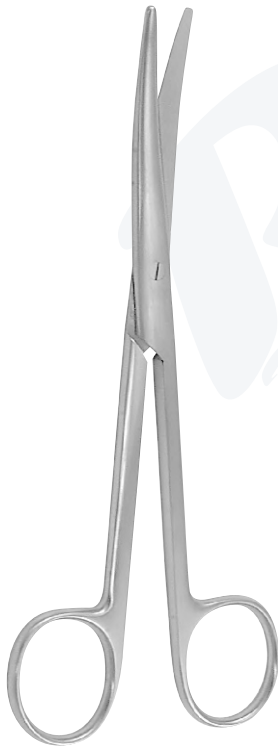

**LEXER-CVD-B/B**



**CVD-B/B**  
16.0 cm, 6¼" RMC-1080-16  
21.0 cm, 8¼" RMC-1080-21

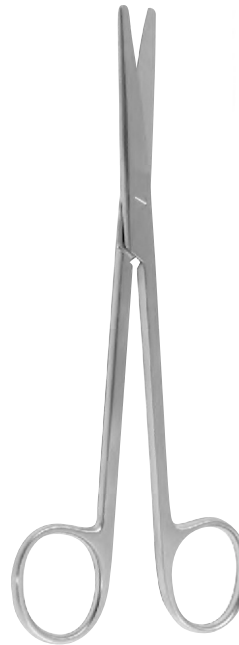

**MIXTER-STR-B/B**  
17.0 cm, 6¼"



**STR-B/B**  
RMC-1081-17



**CVD-B/B**  
RMC-1082-17



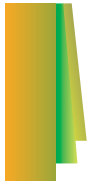

**Dissecting Scissors, ine surgical scissors  
Präparierscheren, feine chirurgische Scheren  
Tijeras de disección, tijeras inas para cirugía  
Forbici per dissezione, forbici ine per chirurgia**



**KILNER (RAGNELL)**

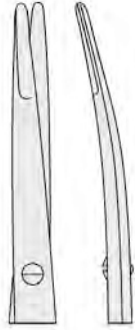

**CVD-B/B**

- 12.0 cm, 4¾" RMC-1083-12
- 15.0 cm, 6" RMC-1083-15
- 18.0 cm, 7" RMC-1083-18
- 20.0 cm, 8" RMC-1083-20



**KILNER (RAGNELL)**



**CVD-S/S**

- 12.0 cm, 4¾" RMC-1084-12
- 15.0 cm, 6" RMC-1084-15
- 18.0 cm, 7" RMC-1084-18
- 20.0 cm, 8" RMC-1084-20

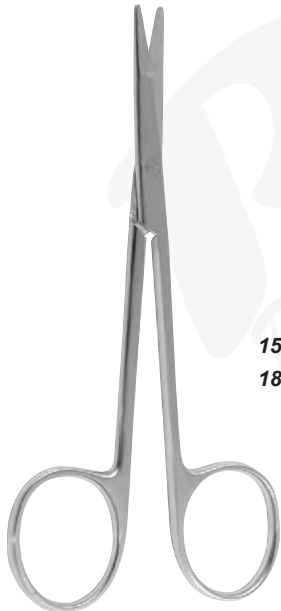

**REYNOLDS**

- 15.0 cm, 6" RMC-1085-15
- 18.0 cm, 7" RMC-108518

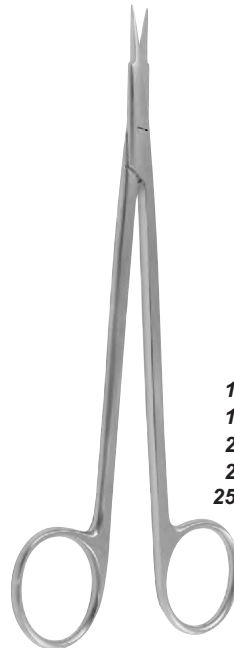

**REYNOLDS**

- 15.0 cm, 6" RMC-1086-15
- 18.0 cm, 7" RMC-1086-18
- 20.0 cm, 8" RMC-1086-20
- 23.0 cm, 9" RMC-1086-23
- 25.0 cm, 10" RMC-1086-25

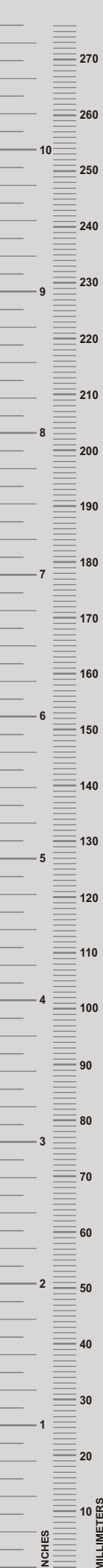

**Fine surgical scissors**  
**Feine chirurgische Scheren**  
**Tijeras inas para cirugía**  
**Forbici inie per chirurgia**

**Nerve dissecting scissors**  
**Nerv-Präparierscheren**  
**Tijeras para nervios**  
**Forbici per dissezione di nervi**

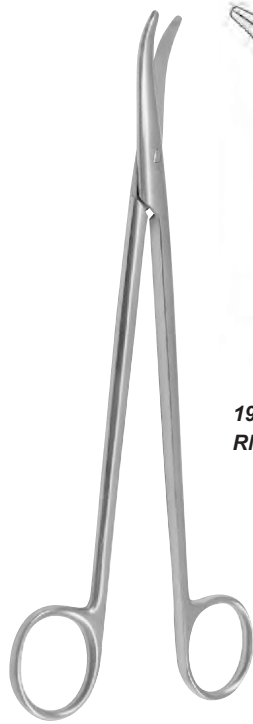

**THOREK-ANGULAR**

**CVD-B/B**  
19.0 cm, 7½"  
RMC-1087-19

**CVD-B/B**  
25.0 cm, 10"  
RMC-1087-25



**SANVENERO**

**STR-S/S**  
15.0 cm, 6"  
RMC-1088-15

**CVD-S/S**  
15.0 cm, 6"  
RMC-1089-15

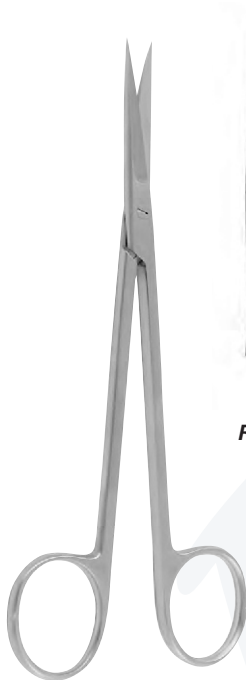

**SANVENERO**  
14.0 cm, 5½"

**STR-S/S**  
RMC-1090-14

**CVD-S/S**  
RMC-1091-14



**JOSEPH**  
14.0 cm, 5½"

**STR-S/S**  
RMC-1092-14

**CVD-S/S**  
RMC-1093-14

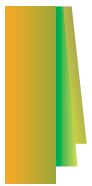

**Fine surgical scissors**  
**Tijeras finas para cirugía**  
**Forbici fine per chirurgia**  
**Feine chirurgische Scheren**

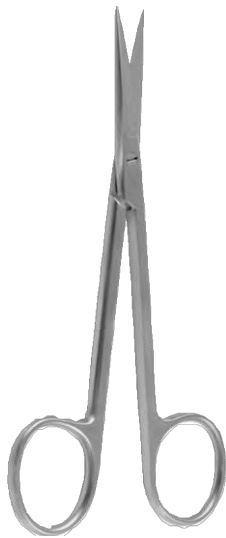

**WAGNER**  
12.0 cm, 4¾"



**STR-B/B**  
RMC-1094-12



**CVD-B/B**  
RMC-1095-12



**STR-S/S**  
RMC-1096-12



**CVD-S/S**  
RMC-1097-12



**STRABISMUS**  
11.5 cm, 4½"



**STR-B/B**  
RMC-1098-11



**CVD-B/B**  
RMC-1099-11



**IRIS**



**STR-S/S**  
9.0 cm, 4⅛" RMC-1100-09  
10.5 cm, 4⅛" RMC-1100-10  
11.5 cm, 4½" RMC-1100-11

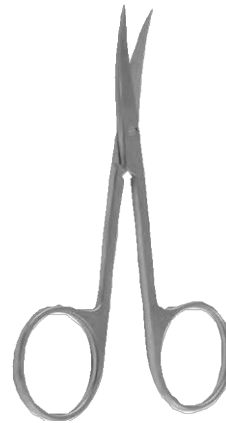

**IRIS**



**CVD-S/S**  
9.0 cm, 4⅛" RMC-1101-09  
10.5 cm, 4⅛" RMC-1101-10  
11.5 cm, 4½" RMC-1101-11



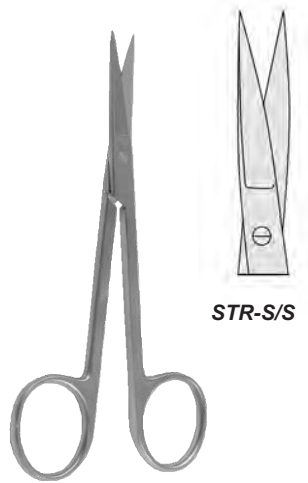

**STR-S/S**

**IRIS**

**10.5 cm, 4<sup>1</sup>/<sub>8</sub>" RMC-1102-10**  
**11.5 cm, 4<sup>1</sup>/<sub>2</sub>" RMC-1102-11**

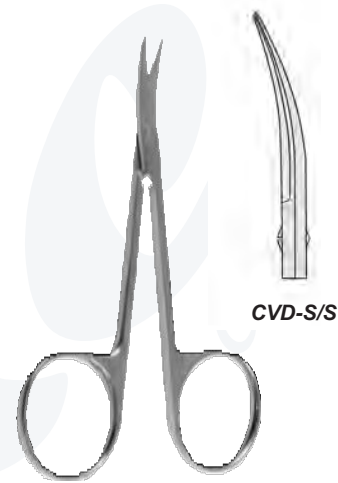

**CVD-S/S**

**IRIS**

**10.5 cm, 4<sup>1</sup>/<sub>8</sub>" RMC-1103-10**  
**11.5 cm, 4<sup>1</sup>/<sub>2</sub>" RMC-1103-11**



**IRIS**

**11.5 cm, 4<sup>1</sup>/<sub>2</sub>"**  
**RMC-1104-11**



**IRIS**

**11.5 cm, 4<sup>1</sup>/<sub>2</sub>"**  
**RMC-1105-11**

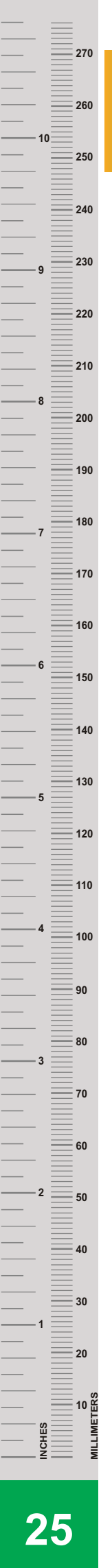

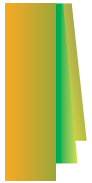

**Fine surgical scissors**  
**Feine chirurgische Scheren**  
**Tijeras finas para cirugía**  
**Forbici fine per chirurgia**

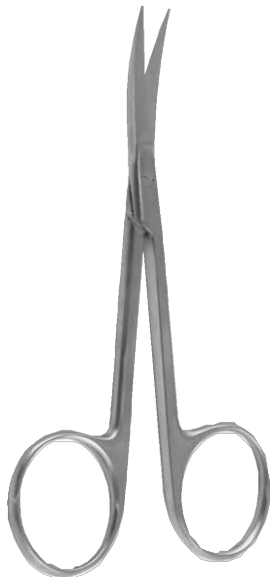

**12.0 cm, 4¾"**



**STR-S/S**  
**RMC-1106-12**



**CVD-S/S**  
**RMC-1107-12**



**STR-S/S**  
**RMC-1108-08**



**MOD. BONN**  
**8.0 cm, 3¼"**



**CVD-S/S**  
**RMC-1109-08**



**MOD. BONN**  
**8.0 cm, 3¼"**



**CVD-S/S**  
**RMC-1110-08**

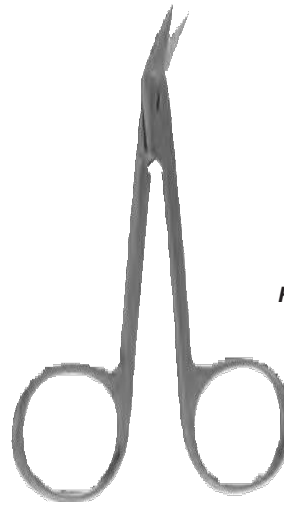

**MOD. BONN**  
**8.0 cm, 3¼"**





**Fine surgical scissors**  
**Feine chirurgische Scheren**  
**Tijeras finas para cirugía**  
**Forbici fine per chirurgia**

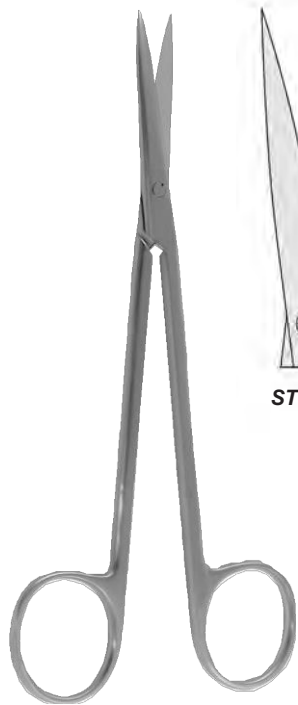

**STR-S/S**

**BROPHY (SULLIVAN)**  
14.0 cm, 5½"  
RMC-1111-14



**CVD-S/S**

**BROPHY (SULLIVAN)**  
14.0 cm, 5½"  
RMC-1112-14

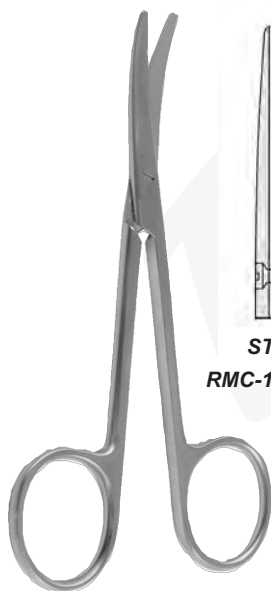

**LANDOLT**  
12.5 cm, 5"

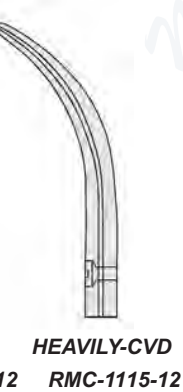

**STEVENS**

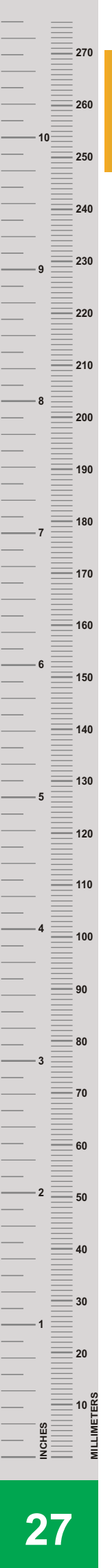
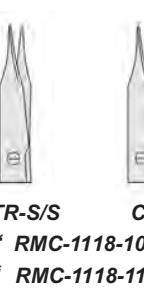



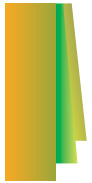

**Incision scissors**  
**Inzisionsscheren**  
**Tijeras para incisión**  
**Forbici vascolare e per fistole**

**13.0 cm, 5"** RMC-1120-13  
**14.5 cm, 5¾"** RMC-1120-14



**RICHTER**  
**14.5 cm, 5¾"**  
**RMC-1121-14**



**FERGUSSON**  
**16.5 cm, 6¼"** RMC-1122-16  
**18.0 cm, 7"** RMC-1122-18



**TOENNIS**  
**18.0 cm, 7"**  
**RMC-1123-18**

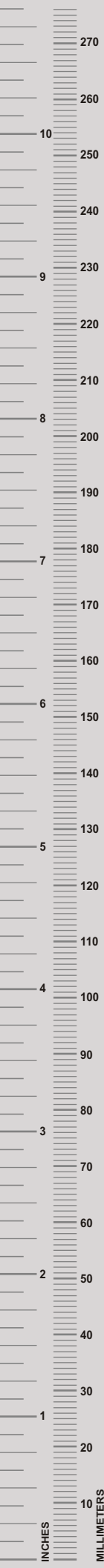
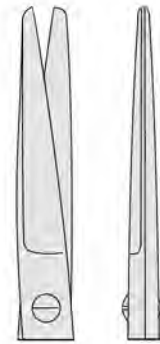

**Surgical scissors, Ligature Scissors**  
**Chirurgische Scheren, Ligaturscheren**  
**Tijeras para cirugía, Tijeras para ligaduras**  
**Forbici per chirurgia, Forbici per legature**

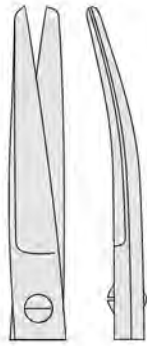
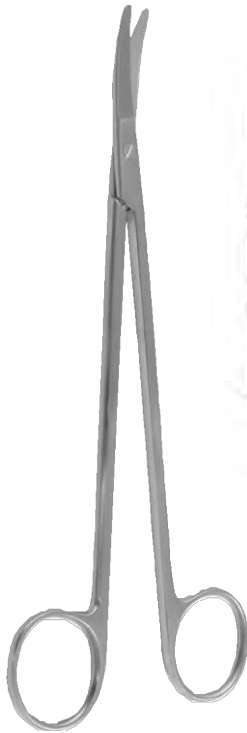

**CVD-B/B**

**TOENNIS**  
18.0 cm, 7"  
RMC-1124-18

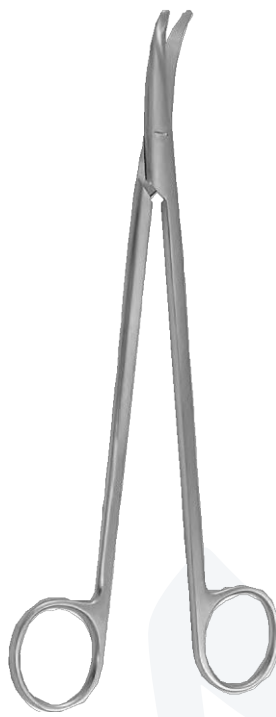

**HALLE**  
19.0 cm, 7½"  
RMC-1125-18



**FOMON**  
15.0 cm, 6"

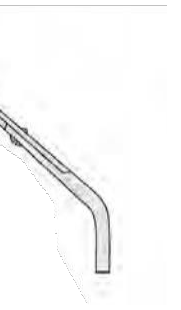

**RMC-1126-15**

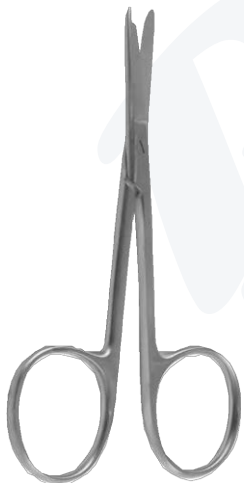
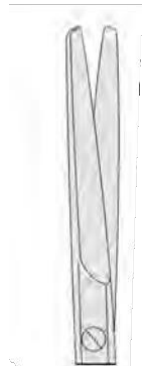

**SPENCER**  
9.0 cm, 4⅞" RMC-1127-09  
10.5 cm, 4⅞" RMC-1127-10  
13.0 cm, 5" RMC-1127-13



**LITTAUER**  
11.5 cm, 4¼" RMC-1128-11  
14.0 cm, 4½" RMC-1128-14

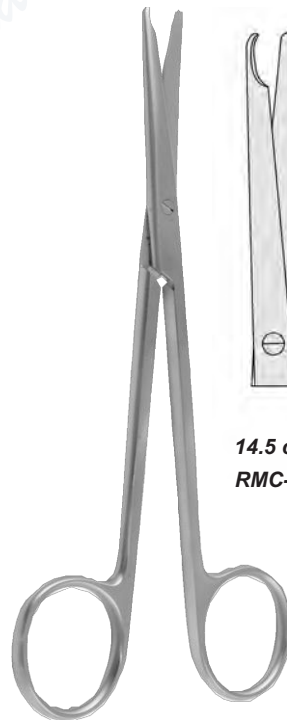

**BUCK**

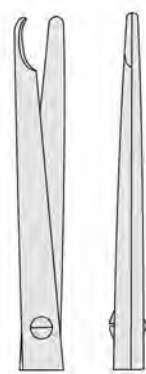

**14.5 cm, 5¾"**  
RMC-1129-14

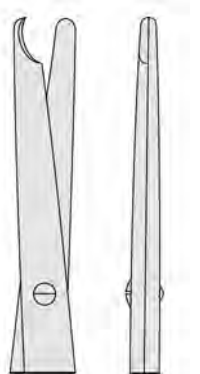

**18.0 cm, 7"**  
RMC-1129-18

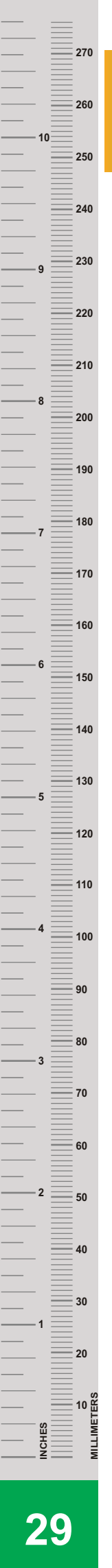

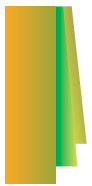

**Ligature Scissors, Neurosurgical Scissors**  
**Ligaturscheren, Neurochirurgische Scheren**  
**Tijeras para ligaduras, Tijeras para Neurocirugía**  
**Forbici per legature, Forbici per Neurochirurgia**

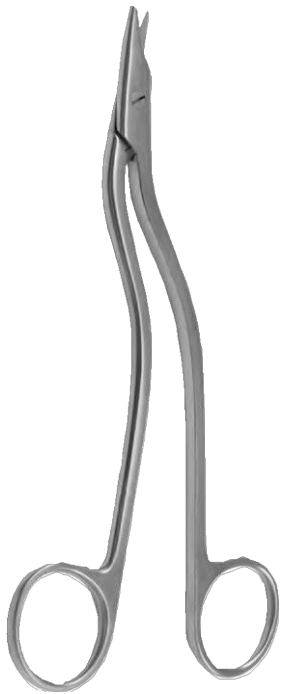

**HEATH**  
16.0 cm, 6¼"  
RMC-1130-16

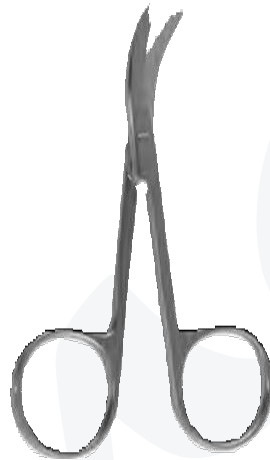

**NORTHBENT**  
9.0 cm, 3½"  
RMC-1131-09



**NORTHBENT**  
13.0 cm, 5"  
RMC-1132-13



**EISELSBERG**  
12.0 cm, 4¾"  
RMC-1133-12



**STRULLY**  
22.0 cm, 8¾"  
RMC-1134-22

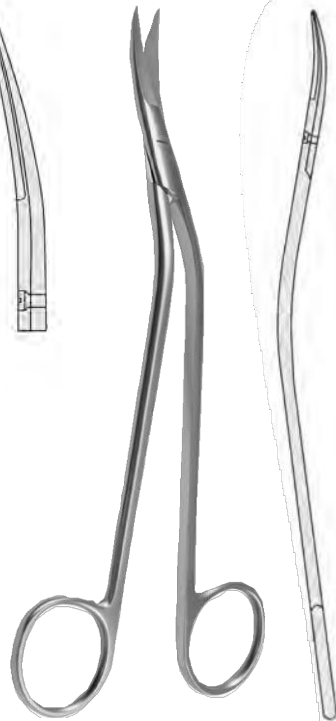

**DANDY**  
17.0 cm, 6¾"  
RMC-1135-17

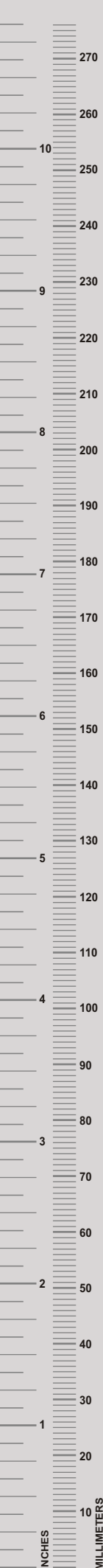

**Neurosurgical Scissors,  
Tonsil Scissors, Nasal Scissors**  
Tijeras para Neurocirugía, Tijeras para amígdalas,  
Tijeras para el tabique nasal,

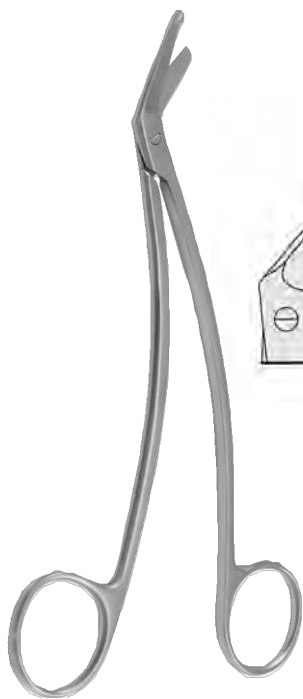

**SCHMIEDEN-TAYLOR**  
17.0 cm, 6¾"  
RMC-1136-17



**LINCOLN**  
17.0 cm, 6¾"

**STR-B/B**  
RMC-1137-17

**CVD-B/B**  
RMC-1138-17

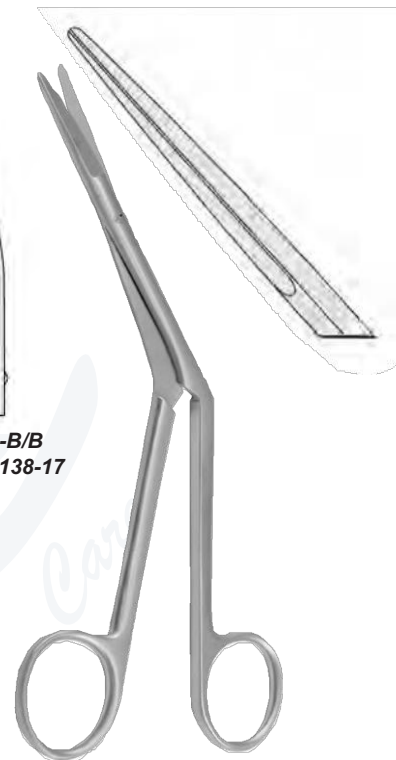

**HEYMANN**  
18.0 cm, 7"  
RMC-1139-18

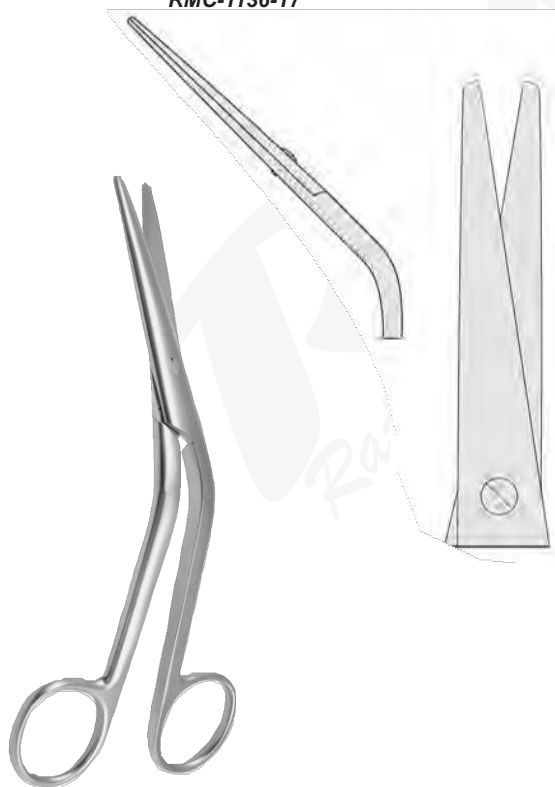

**COTTLE**  
16.0 cm, 6¼"  
RMC-1140-18



**KIRSTEN**  
18.0 cm, 7"  
RMC-1141-18



**CAPLAN**  
22.0 cm, 8⅝"  
RMC-1142-22

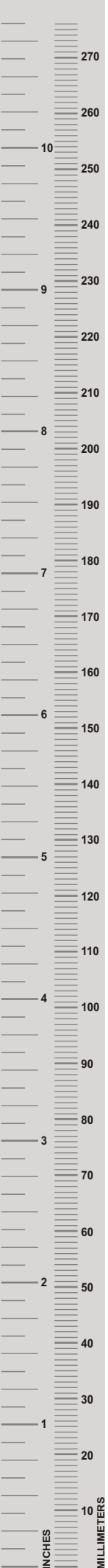

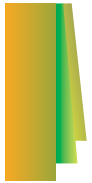

**Tonsil Scissors, Nasal Scissors, Vascular Scissors**  
**Tonsillenscheren, Nasenscheren, Gefäßscheren**  
**Tijeras para amígdalas,**  
**Forbici per tonsille, Forbici per il setto nasale,**

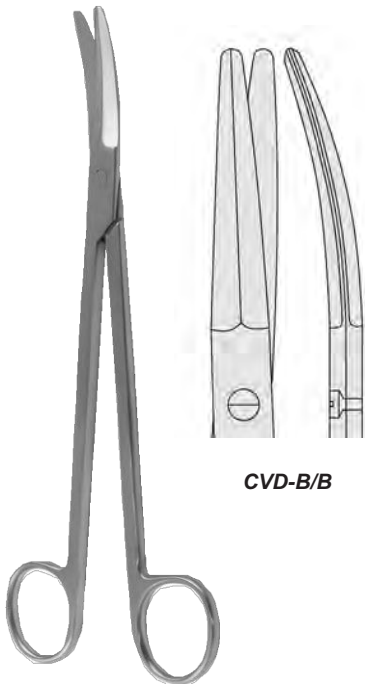

**CVD-B/B**

**BOETTCHER**  
 18.0 cm, 7"  
 RMC-1143-18

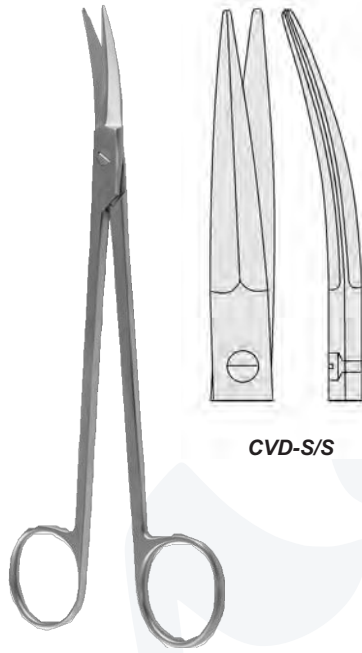

**CVD-S/S**

**PRINCE**  
 17.5 cm, 6 5/8"  
 RMC-1144-18

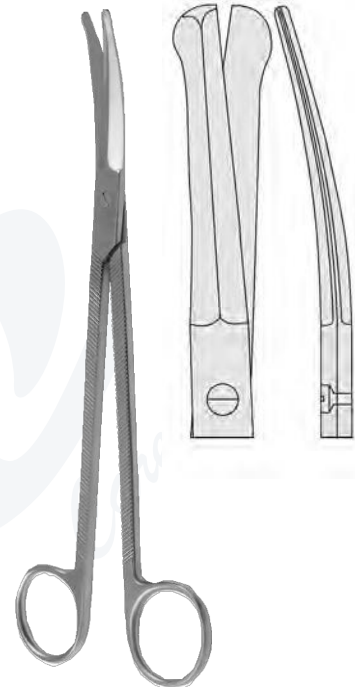

**GOOD**  
 19.0 cm, 7 1/2"  
 RMC-1145-19



**CARTILAGE**  
 20.0 cm, 8"  
 RMC-1146-20

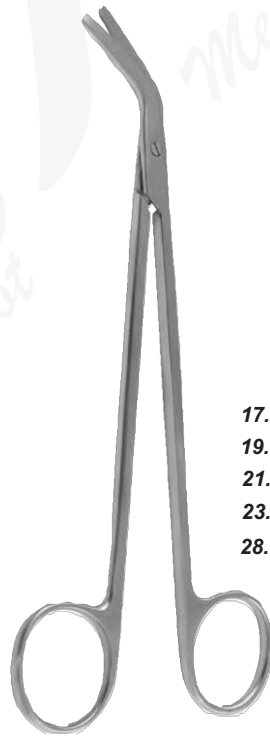

**DE BAKEY**

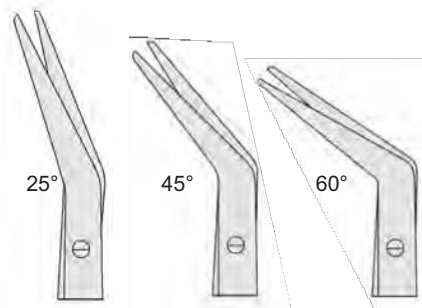

	<b>SLIGHTLY-CVD</b>	<b>STRONGLY-CVD</b>	<b>HEAVILY-CVD</b>
	17.5 cm, 6 5/8" RMC-1147-25	RMC-1147-45	RMC-1147-60
	19.5 cm, 7 3/4" RMC-1148-25	RMC-1148-45	RMC-1148-60
	21.0 cm, 8 1/4" RMC-1149-25	RMC-1149-45	RMC-1149-60
	23.0 cm, 9" RMC-1150-25	RMC-1150-45	RMC-1150-60
	28.0 cm, 11" RMC-1151-25	RMC-1151-45	RMC-1151-60

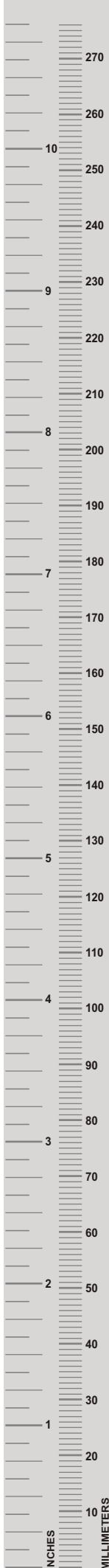



**POTTS-SMITH-ANGULAR**  
18.0 cm, 7"  
RMC-1152-18

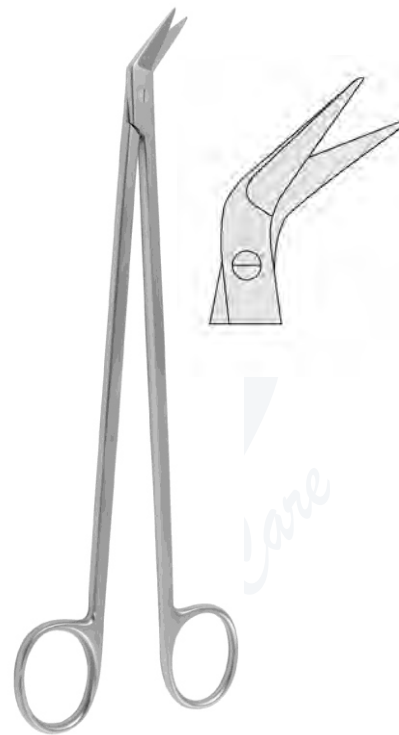
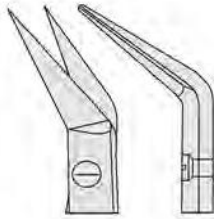

**POTTS DE MARTEL-ANGULAR**  
21.0 cm, 8¼" RMC-1153-21  
24.0 cm, 9½" RMC-1153-24

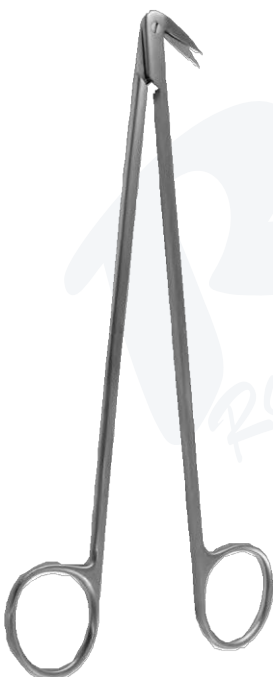

**DIETHRICH-HEGEMANN-ANGULAR**  
19.0 cm, 7½"



RMC-1154-25



RMC-1154-45

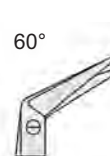

RMC-1154-60

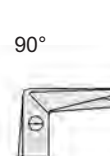

RMC-1154-90



RMC-1154-12



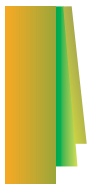

**Vascular Scissors**  
**Gefäßscheren**  
**Tijeras vasculares**  
**Forbici vascolari**

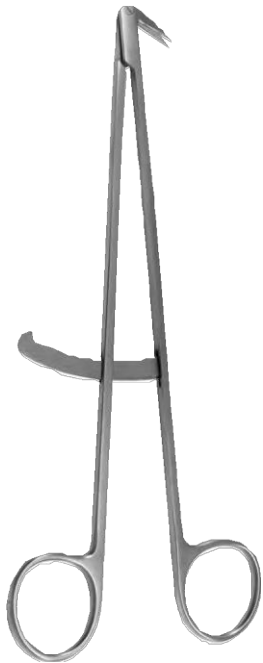

**DIETRICH-ANGULAR**  
20.0 cm, 7½"  
RMC-1155-20

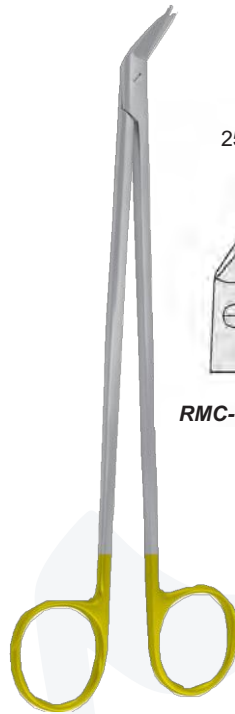

**POTTS-SMITH-ANGULAR**  
19.0 cm, 7½"

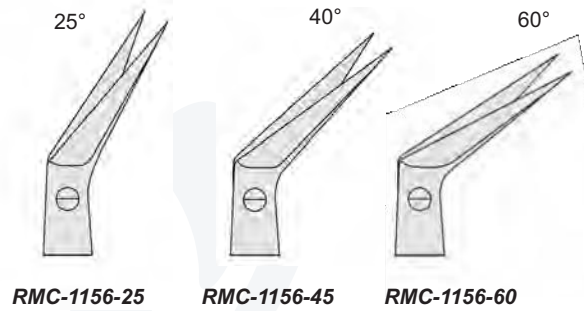

**DE BAKEY**  
15.5 cm, 6"  
RMC-1157-15

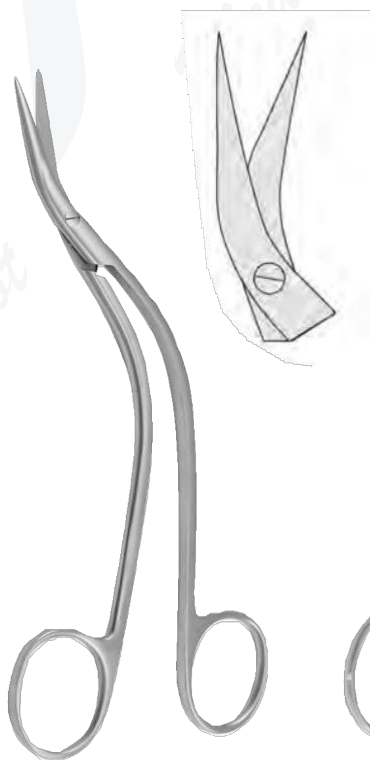

**DE BAKEY**  
15.5 cm, 6"  
RMC-1158-15



**DE BAKEY**  
15.5 cm, 6"  
RMC-1159-15

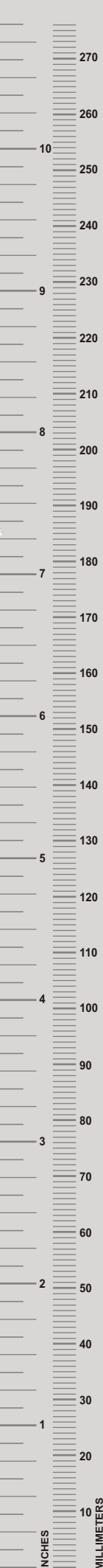

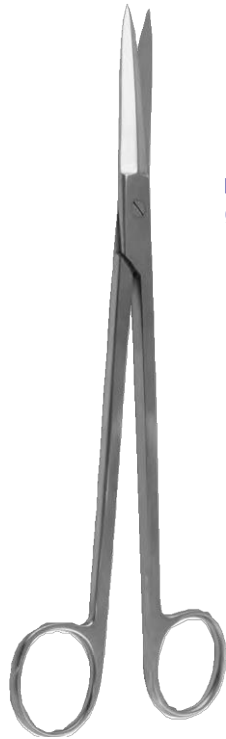
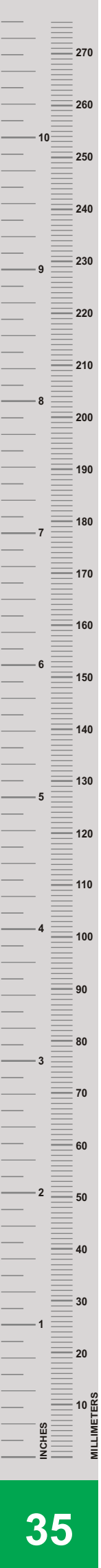

**MC INDOE**  
 19.0 cm, 7½"  
 RMC-1160-19

probe-pointed blade  
 geknöpftes Blatt  
 punta botonda  
 lame bottonuta



11.5 cm, 4½"  
 RMC-1161-11



**CRAFOORD**  
 30.0 cm, 12"  
 RMC-1162-30

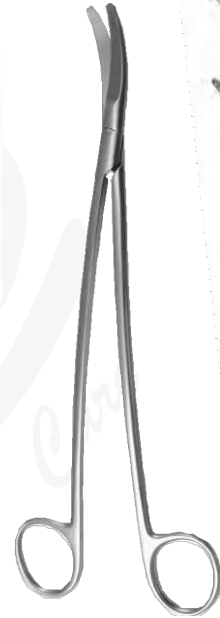

**SATINSKY**  
 15.5 cm, 9⅝"  
 RMC-1163-15

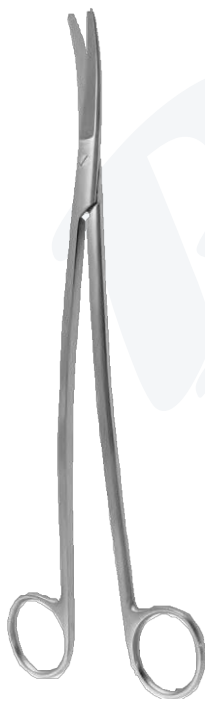

**KLINGENBERG-LOTH**  
 23.0 cm, 9"  
 RMC-1164-23

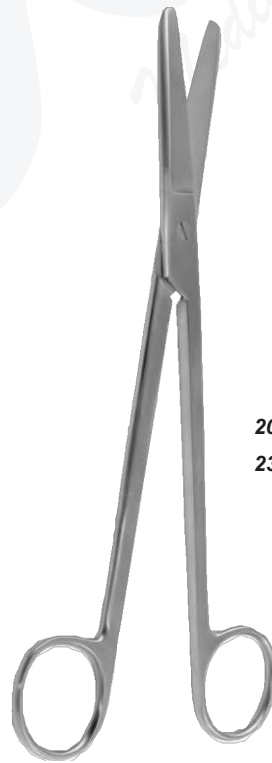

**SIMS**



**STR-B/B**  
 20.0 cm, 8"  
 RMC-1165-20



**STR-S/B**  
 RMC-1166-20



**STR-S/S**  
 RMC-1167-20

23.0 cm, 9" RMC-1165-23 RMC-1166-23 RMC-1167-23



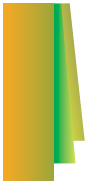

**Gynecology scissors**  
**Tijeras para ginecología**  
**Forbici per ginecologia**  
**Gynäkologische Scheren**

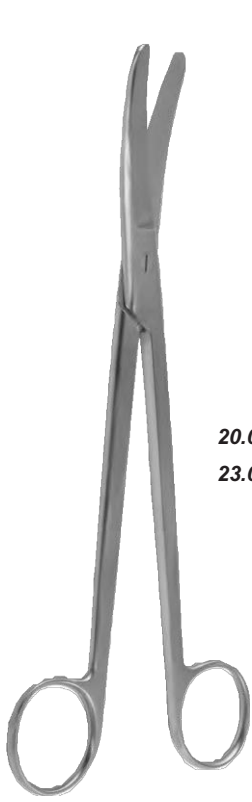

**SIMS**



**CVD-B/B**  
20.0 cm, 8" RMC-1168-20  
23.0 cm, 9" RMC-1168-23



**CVD-S/B**  
RMC-1169-20  
RMC-1169-23



**CVD-B/B**  
RMC-1170-20  
RMC-1170-23

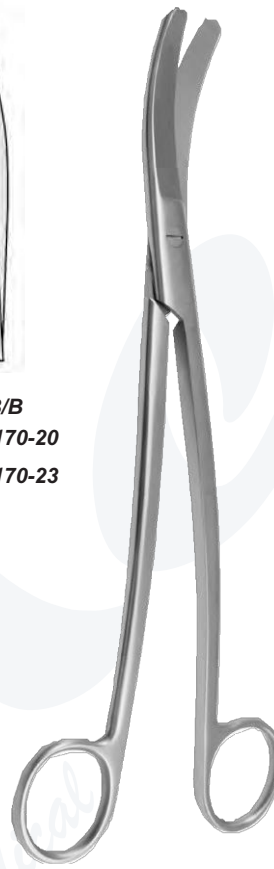

**SIEBOLD**  
24.0 cm, 9½"  
RMC-1171-24



**BOZEMANN**  
22.0 cm, 8¾"  
RMC-1172-22



**DOYEN**



**STR-B/B**  
16.0 cm, 6¼" RMC-1173-16  
17.5 cm, 6¾" RMC-1173-17



**CVD-B/B**  
RMC-1174-16  
RMC-1174-17



**STR-S/B**  
RMC-1175-16  
RMC-1175-17

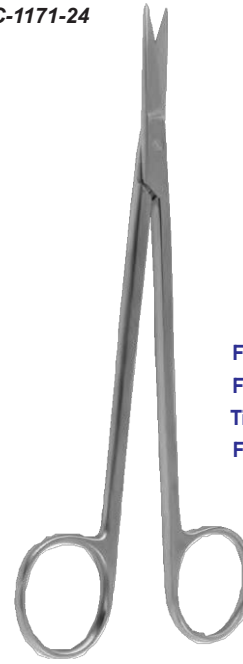

**KELLY-STR**  
16.0 cm, 6¼" RMC-1176-16  
18.0 cm, 7" RMC-1176-18

**Fistula scissors**  
**Fistelscheren**  
**Tijeras para fistulas**  
**Forbici per fistole**



**Gynecology scissors, Enterotomy Scissors**  
**Tijeras para ginecología, Tijeras enterótomos**  
**Forbici per ginecologia, Forbici per enterotomia**  
**Gynäkologische Scheren, Darmscheren**

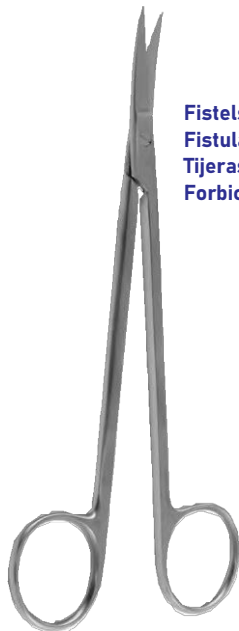

**Fistelscheren**  
**Fistula scissors**  
**Tijeras para fistulas**  
**Forbici per fistole**

**KELLY-CVD**  
 16.0 cm, 6¼" RMC-1177-16  
 18.0 cm, 7" RMC-1177-18

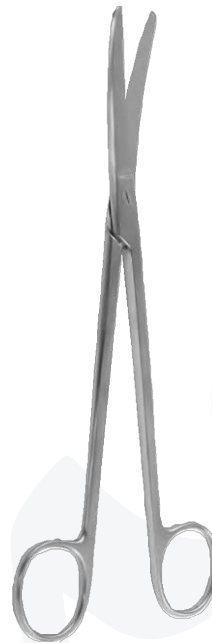

**WERTHEIM**  
 19.5 cm, 7¾" RMC-1178-16  
 22.5 cm, 8¾" RMC-1178-22



**DUBOIS**  
 27.0 cm, 10⅝"



RMC-1279-27



21.0 cm, 8¼"  
 RMC-1180-21



21.0 cm, 8¼"  
 RMC-1181-21



21.0 cm, 8¼"  
 RMC-1182-21



**LLOYD-DAVIES**  
 27.0 cm, 10⅝"  
 RMC-1183-27

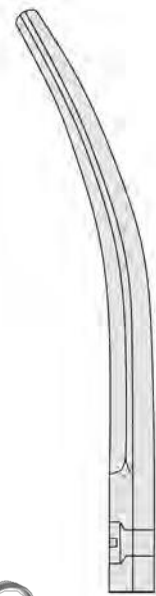

CVD-B/B



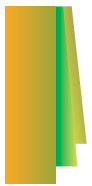

**Lobectomy and Rectal Scissors,  
Lobectomy Scissors,  
Forbici per lobo polmonare e per il retto,  
Forbici per lobo, ,**

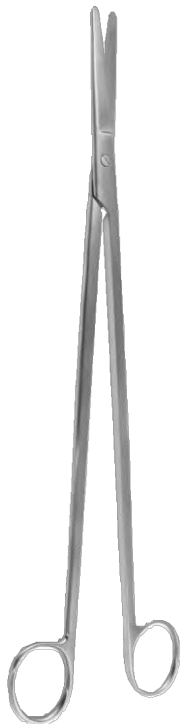

**STR-B/B**  
RMC-1184-31

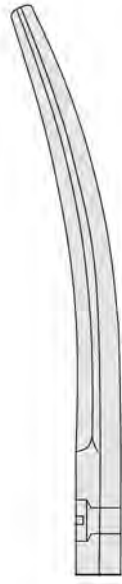

**CVD-B/B**  
RMC-1185-31



**RECTAL**  
32.5 cm, 12¾"  
RMC-1186-32



**CVD-B/B**



**WILLAUER**  
25.0 cm, 9¾" RMC-1187-25  
28.0 cm, 11" RMC-1187-28



**STR-B/B**



**WILLAUER**  
25.0 cm, 9¾" RMC-1188-25  
28.0 cm, 11" RMC-1188-28



**CVD-B/B**



**POTTS-SMITH**  
19.0 cm, 7½"  
RMC-1189-19



**CVD-B/B**



**FINOCHIETTO**  
32.5 cm, 10¾"  
RMC-1190-27



**CVD-S/S**

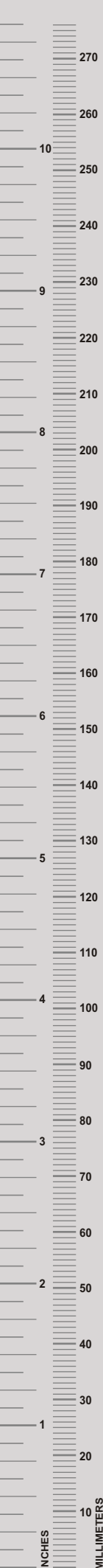

**Lobectomy Scissors, Episiotomy Scissors,  
Tijeras umbilicales**  
**Tijera para lobectomía, Tijeras para episiotomía,  
Forbici per lobo, Forbici per episiotomia,**



**WALDMANN**  
18.0 cm, 7"  
RMC-1191-18

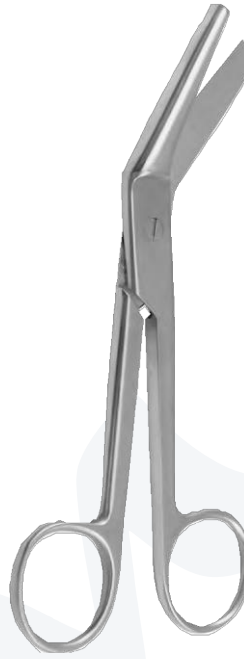

**BRAUN-STADLER**  
14.5 cm, 5<sup>3</sup>/<sub>4</sub>" RMC-1192-14  
20.0 cm, 8" RMC-1192-20



20.0 cm, 8"  
RMC-1193-20



**MOD. USA**  
10.5 cm, 4<sup>1</sup>/<sub>8</sub>"  
RMC-1194-10



**BUSCH**  
13.5 cm, 5<sup>5</sup>/<sub>8</sub>" RMC-1195-13  
16.0 cm, 6<sup>1</sup>/<sub>4</sub>" RMC-1195-16



**SCHUMACHER**  
16.0 cm, 16<sup>1</sup>/<sub>4</sub>"  
RMC-1196-16



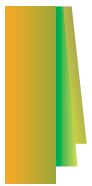

**Wire Scissors, Bandage and Cloth Scissors**  
**Drahtscheren, Verband-und Kleiderstoffscheren**  
**Forbici taglia cavo,**



serrated  
gezahnt  
dentada  
dentata

**UNIVERSAL**  
12.0 cm, 4 3/4"  
RMC-1197-12



**LISTER**

- 9.0 cm, 3 1/2" RMC-1198-09
- 11.0 cm, 4 3/8" RMC-1198-11
- 14.0 cm, 5 1/2" RMC-1198-14
- 18.0 cm, 7" RMC-1198-18
- 20.0 cm, 8" RMC-1198-20



**LISTER**  
18.5 cm, 7 1/4" RMC-1199-18  
21.0 cm, 8 1/4" RMC-1199-21

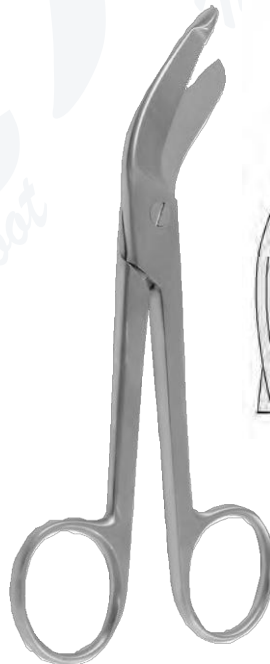

**LISTER-EXCENTRIC**  
16.0 cm, 6 1/4" RMC-1200-16  
19.0 cm, 7 1/2" RMC-1200-19

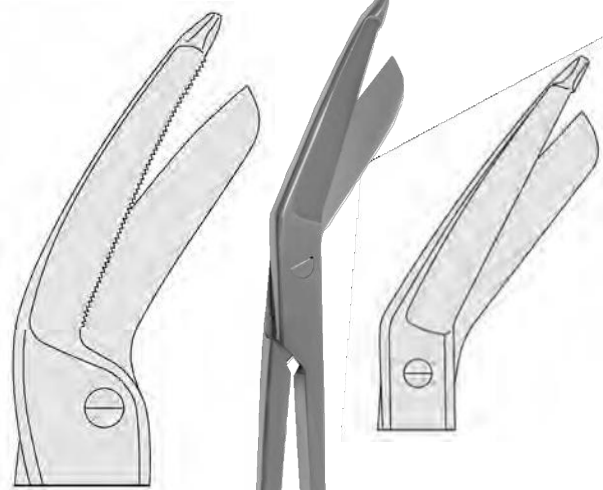

serrated  
dentada  
dentata  
gezahnt

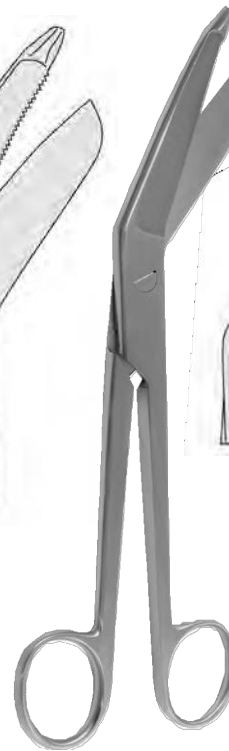

**BERGMANN**  
23.0 cm, 9"  
RMC-1201-23

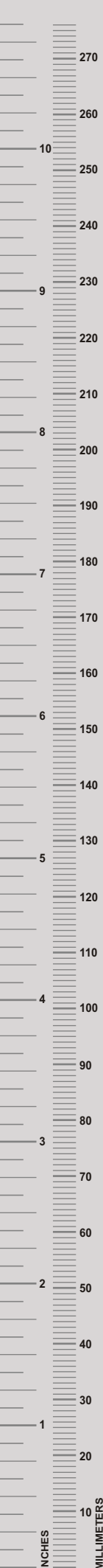

INCHES  
MILLIMETERS

**Bandage and Cloth Scissors,  
Tijeras para vendajes y tela, Cizallas para escayolas  
Forbici per bendaggi e vestiti, Cesoi per gessi  
Verband-und Kleiderstoffscheren, Gipsscheren**

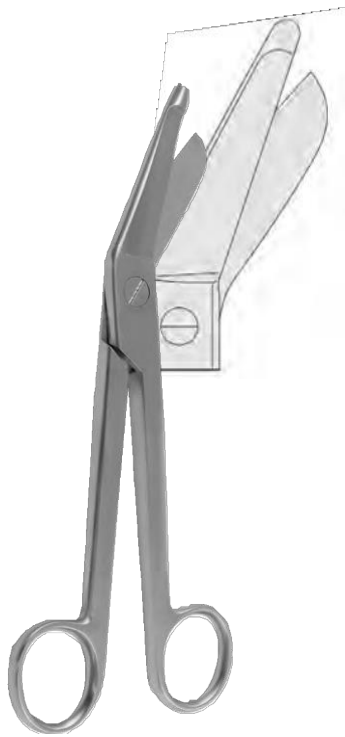

**ESMARCH**  
20.0 cm, 8" RMC-1202-20  
22.0 cm, 8 5/8" RMC-1202-22



**KNOWLES**  
14.0 cm, 5 1/2" RMC-1203-14

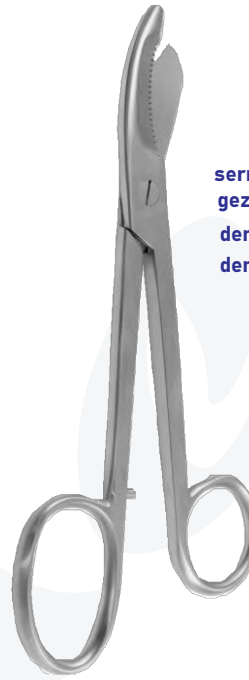

**BRUNS**  
24.0 cm, 9 1/2" RMC-1204-24

serrated  
gezahnt  
dentada  
dentata

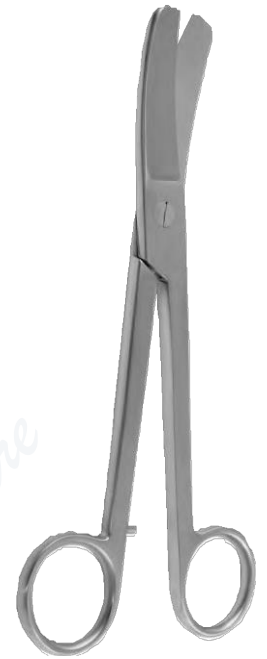

**LORENZ**  
23.0 cm, 9" RMC-1205-23

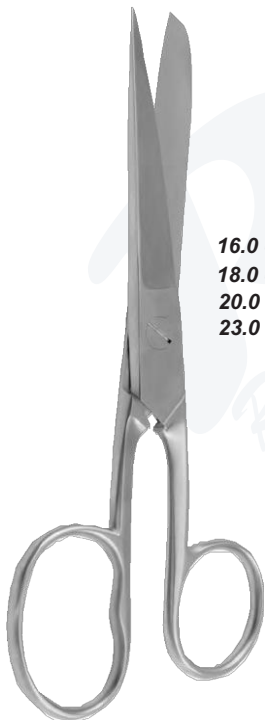

**SMITH  
(MOD. USA)**

16.0 cm, 6 1/4" RMC-1206-16  
18.0 cm, 7" RMC-1206-18  
20.0 cm, 8" RMC-1206-20  
23.0 cm, 9" RMC-1206-23



**20.0 cm, 8" RMC-1207-20**

autoclavable up to 134°C  
bis 134°C autoklavierbar  
esterilizable en autoclave hasta 134°C  
Sterilizzabile in autoclave fino 134°C

serrated  
gezahnt  
dentada  
dentata



**UNIVERSAL**  
14.0 cm, 5 1/2" RMC-1208-14  
16.0 cm, 6 1/4" RMC-1208-16  
18.0 cm, 7" RMC-1208-18

serrated  
gezahnt  
dentada  
dentata



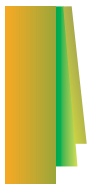

**Surgical Scissors with tungsten carbide edges**  
**Tijeras para cirugía con filos de carburo tungsteno**  
**Chirurgische Scheren mit Hartmetallschneiden**  
**Forbici per chirurgia con lame in carburo di tungsteno**

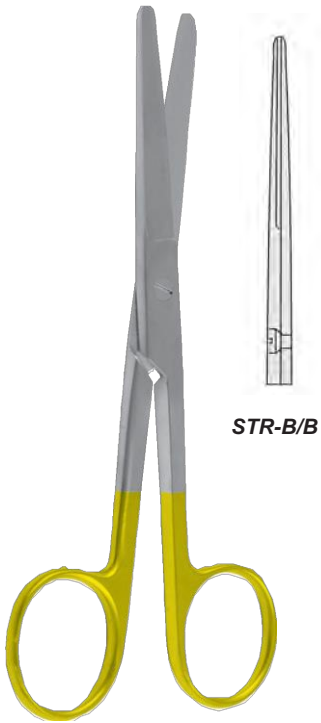

**STR-B/B**

**STANDARD**

- 14.5 cm, 5<sup>3</sup>/<sub>4</sub>" RMC-1209-14
- 16.5 cm, 6<sup>1</sup>/<sub>2</sub>" RMC-1209-16
- 18.5 cm, 7<sup>1</sup>/<sub>4</sub>" RMC-1209-18



**CVD-B/B**

**STANDARD**

- 14.5 cm, 5<sup>3</sup>/<sub>4</sub>" RMC-1210-14
- 16.5 cm, 6<sup>1</sup>/<sub>2</sub>" RMC-1210-16
- 18.5 cm, 7<sup>1</sup>/<sub>4</sub>" RMC-1210-18

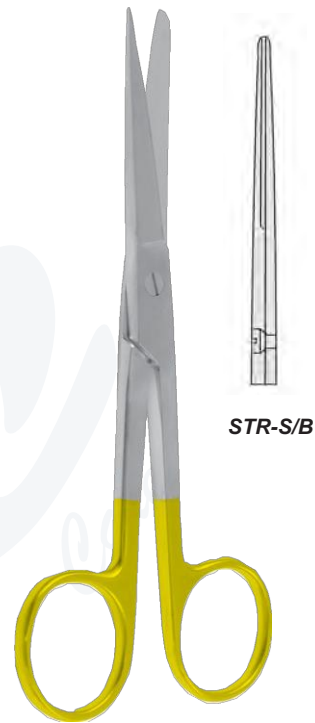

**STR-S/B**

**STANDARD**

- 14.5 cm, 5<sup>3</sup>/<sub>4</sub>" RMC-1211-14
- 16.5 cm, 6<sup>1</sup>/<sub>2</sub>" RMC-1211-16
- 18.5 cm, 7<sup>1</sup>/<sub>4</sub>" RMC-1211-18

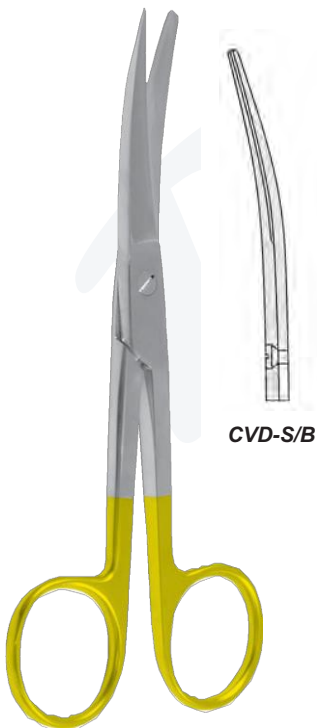

**CVD-S/B**

**STANDARD**

- 14.5 cm, 5<sup>3</sup>/<sub>4</sub>" RMC-1212-14
- 16.5 cm, 6<sup>1</sup>/<sub>2</sub>" RMC-1212-16
- 18.5 cm, 7<sup>1</sup>/<sub>4</sub>" RMC-1212-18

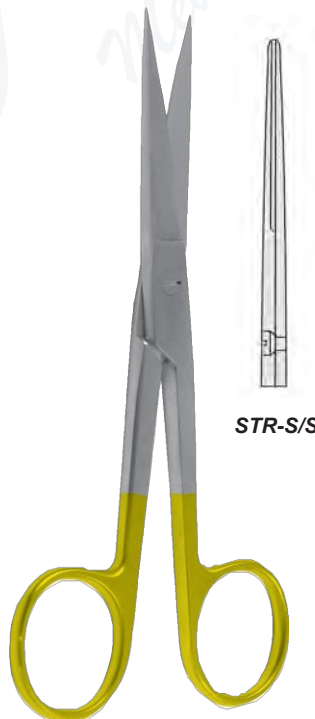

**STR-S/S**

**STANDARD**

- 14.5 cm, 5<sup>3</sup>/<sub>4</sub>" RMC-1213-14
- 16.5 cm, 6<sup>1</sup>/<sub>2</sub>" RMC-1213-16
- 18.5 cm, 7<sup>1</sup>/<sub>4</sub>" RMC-1213-18

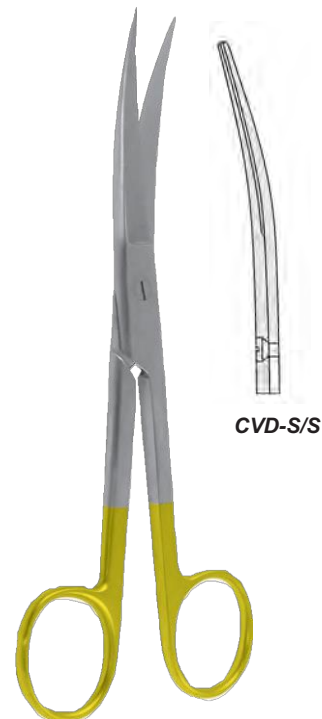

**CVD-S/S**

**STANDARD**

- 14.5 cm, 5<sup>3</sup>/<sub>4</sub>" RMC-1214-14
- 16.5 cm, 6<sup>1</sup>/<sub>2</sub>" RMC-1214-16
- 18.5 cm, 7<sup>1</sup>/<sub>4</sub>" RMC-1214-18

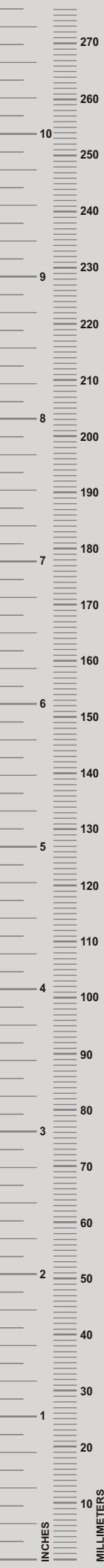



STR-B/B

**MAYO**  
14.5 cm, 5¾" RMC-1215-14  
17.0 cm, 6¾" RMC-1215-17  
23.0 cm, 9" RMC-1215-23



CVD-B/B

**MAYO**  
14.5 cm, 5¾" RMC-1216-14  
17.0 cm, 6¾" RMC-1216-17  
23.0 cm, 9" RMC-1216-23



STR-B/B

**MAYO-STILLE**  
15.0 cm, 6" RMC-1217-15  
17.0 cm, 6¾" RMC-1217-17

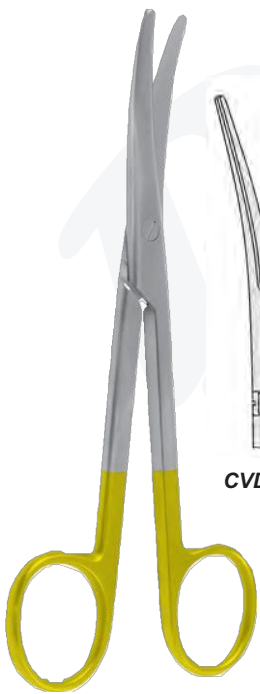

CVD-B/B

**MAYO-STILLE**  
15.0 cm, 6" RMC-1218-15  
17.0 cm, 6¾" RMC-1218-17



STR-B/B

**LEXER**  
16.0 cm, 6¼" RMC-1219-16  
21.0 cm, 8¼" RMC-1219-21



CVD-B/B

**LEXER**  
16.0 cm, 6¼" RMC-1220-16  
21.0 cm, 8¼" RMC-1220-21



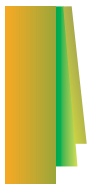

**Dissecting Scissors with tungsten carbide edges**  
**Präparierscheren mit Hartmetallschneiden**  
**Tijeras para disección con fillos de carburo**  
**Forbici per dissezione con lame in carburo**



**STR-B/B**  
RMC-1221-11

**STR-B/B** RMC-1223-14    **CVD-B/B** RMC-1224-14

**STR-B/B** RMC-1225-14    **CVD-B/B** RMC-1226-14

**BABY-METZENBAUM**  
11.5 cm, 4 1/4"

**METZENBAUM**  
14.5 cm, 5 3/4"

**METZENBAUM**  
14.5 cm, 5 3/4"

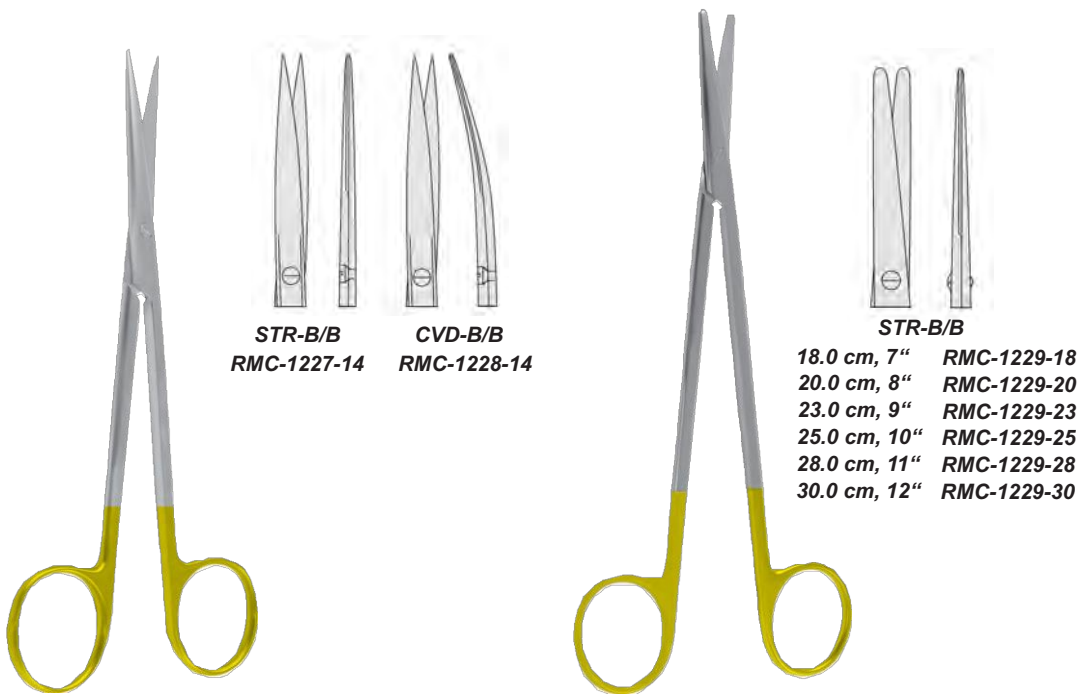

**STR-B/B** RMC-1227-14    **CVD-B/B** RMC-1228-14

**STR-B/B**  
 18.0 cm, 7" RMC-1229-18  
 20.0 cm, 8" RMC-1229-20  
 23.0 cm, 9" RMC-1229-23  
 25.0 cm, 10" RMC-1229-25  
 28.0 cm, 11" RMC-1229-28  
 30.0 cm, 12" RMC-1229-30

**METZENBAUM**  
14.5 cm, 5 3/4"

**METZENBAUM**



**Dissecting Scissors with tungsten carbide edges**  
**Präparierscheren mit Hartmetallschneiden**  
**Tijeras para disección con filos de carburo**  
**Forbici per dissezione con lame in carburo**

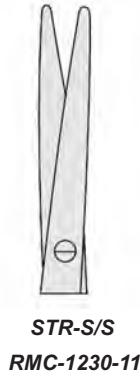

**STR-S/S**  
**RMC-1230-11**

**BABY-METZENBAUM**  
**11.5 cm, 4 1/4"**

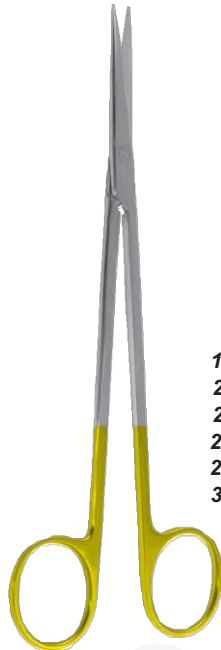

**CVD-S/B**  
**18.0 cm, 7"** RMC-1231-18  
**20.0 cm, 8"** RMC-1231-20  
**23.0 cm, 9"** RMC-1231-23  
**25.0 cm, 10"** RMC-1231-25  
**28.0 cm, 11"** RMC-1231-28  
**30.0 cm, 12"** RMC-1231-30

**METZENBAUM**

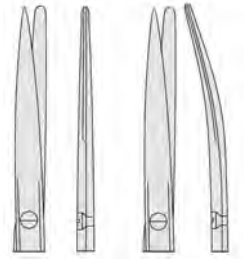
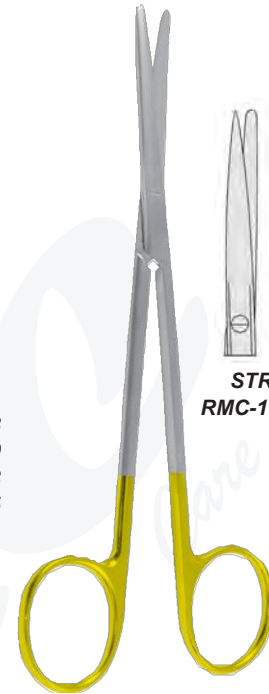

**STR-S/B** RMC-1232-14  
**CVD-S/B** RMC-1233-14

**METZENBAUM**  
**14.5 cm, 5 3/4"**

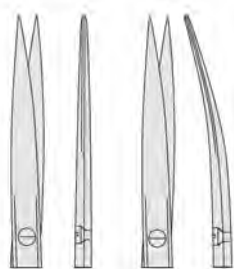
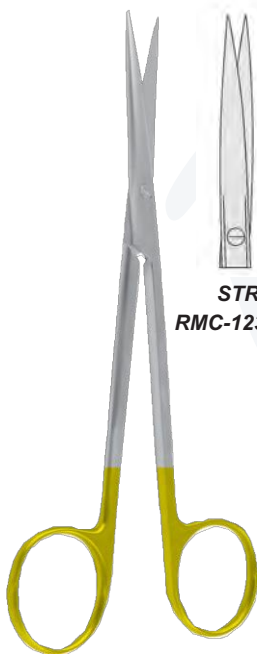

**STR-S/S** RMC-1234-14  
**CVD-S/S** RMC-1235-14

**METZENBAUM**  
**14.5 cm, 5 3/4"**

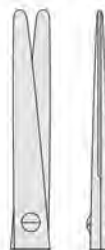
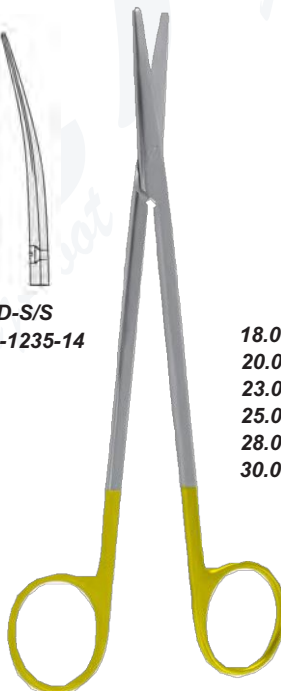

**STR-S/S**  
**18.0 cm, 7"** RMC-1236-18  
**20.0 cm, 8"** RMC-1236-20  
**23.0 cm, 9"** RMC-1236-23  
**25.0 cm, 10"** RMC-1236-25  
**28.0 cm, 11"** RMC-1236-28  
**30.0 cm, 12"** RMC-1236-30

**METZENBAUM**

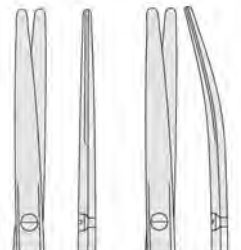
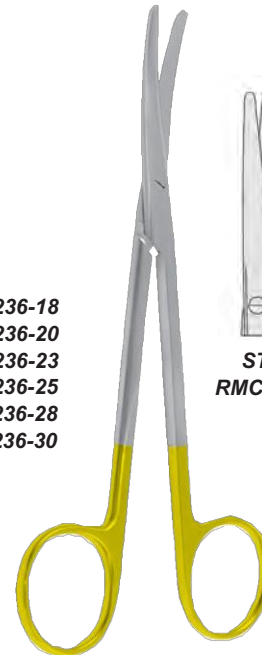

**STR-B/B** RMC-1237-14  
**CVD-B/B** RMC-1238-14

INCHES  
MILLIMETERS

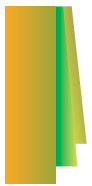

**Dissecting Scissors with tungsten carbide edges Tijeras  
Präparierscheren mit Hartmetallschneiden  
para disección con filos de carburo tungsteno Forbici  
per dissezione con lame in carburo di tungsteno**

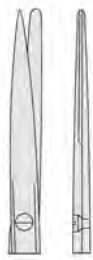
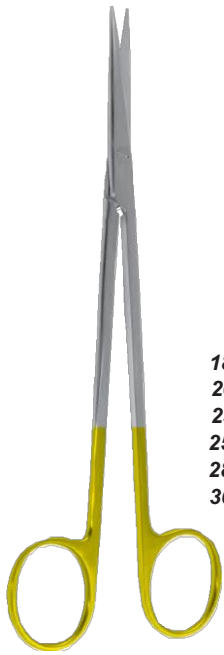

**STR-S/B**

- 18.0 cm, 7" RMC-1239-18
- 20.0 cm, 8" RMC-1239-20
- 23.0 cm, 9" RMC-1239-23
- 25.0 cm, 10" RMC-1239-25
- 28.0 cm, 11" RMC-1239-28
- 30.0 cm, 12" RMC-1239-30

**METZENBAUM**

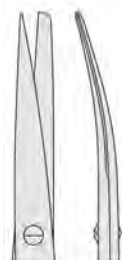
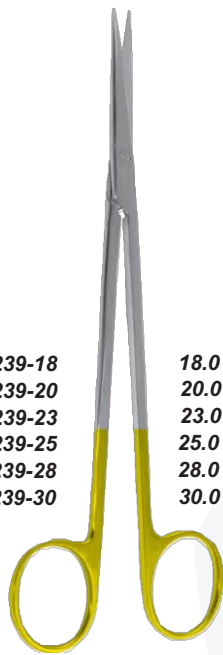

**CVD-S/B**

- 18.0 cm, 7" RMC-1240-18
- 20.0 cm, 8" RMC-1240-20
- 23.0 cm, 9" RMC-1240-23
- 25.0 cm, 10" RMC-1240-25
- 28.0 cm, 11" RMC-1240-28
- 30.0 cm, 12" RMC-1240-30

**METZENBAUM**

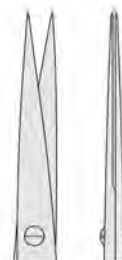
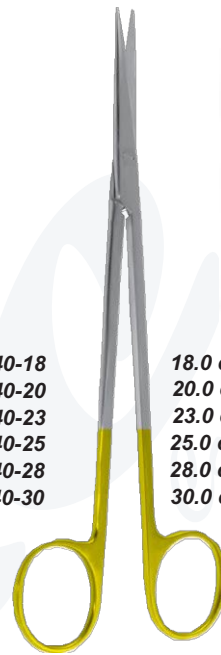

**STR-S/S**

- 18.0 cm, 7" RMC-1241-18
- 20.0 cm, 8" RMC-1241-20
- 23.0 cm, 9" RMC-1241-23
- 25.0 cm, 10" RMC-1241-25
- 28.0 cm, 11" RMC-1241-28
- 30.0 cm, 12" RMC-1241-30

**METZENBAUM**

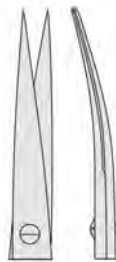

**CVD-S/S**

- 18.0 cm, 7" RMC-1242-18
- 20.0 cm, 8" RMC-1242-20
- 23.0 cm, 9" RMC-1242-23
- 25.0 cm, 10" RMC-1242-25
- 28.0 cm, 11" RMC-1242-28
- 30.0 cm, 12" RMC-1242-30

**METZENBAUM**

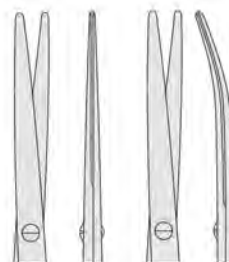
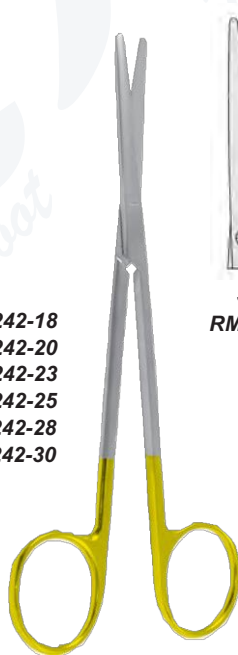

**STR-B/B**

- RMC-1243-14

**METZENBAUM-FINO**

14.5 cm, 5 3/4"

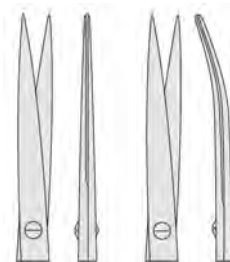
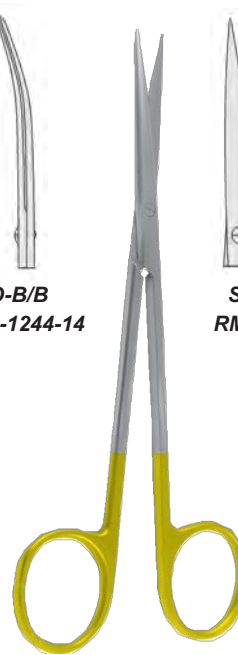

**STR-S/S**

- RMC-1245-14

**METZENBAUM-FINO**

14.5 cm, 5 3/4"



**Dissecting Scissors with tungsten carbide edges**  
**Präparierscheren mit Hartmetallschneiden**  
**Tijeras para disección con fillos de carburo tungsteno**  
**Forbici per dissezione con lame in carburo di tungsteno**

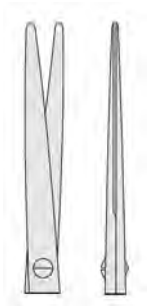
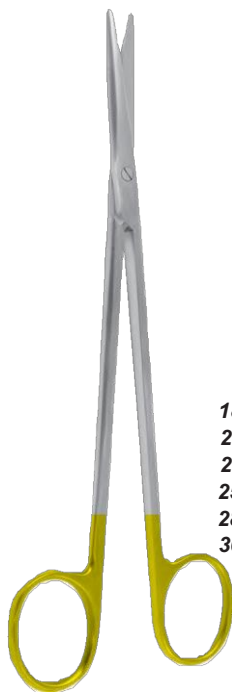

**STR-B/B**

- 18.0 cm, 7" RMC-1247-18
- 20.0 cm, 8" RMC-1247-20
- 23.0 cm, 9" RMC-1247-23
- 25.0 cm, 10" RMC-1247-25
- 28.0 cm, 11" RMC-1247-28
- 30.0 cm, 12" RMC-1247-30

**METZENBAUM-FINO**

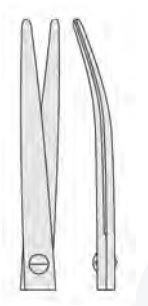
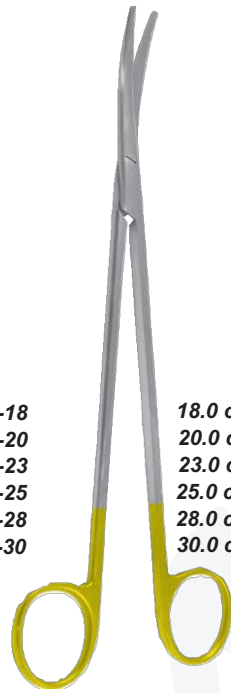

**CVD-B/B**

- 18.0 cm, 7" RMC-1248-18
- 20.0 cm, 8" RMC-1248-20
- 23.0 cm, 9" RMC-1248-23
- 25.0 cm, 10" RMC-1248-25
- 28.0 cm, 11" RMC-1248-28
- 30.0 cm, 12" RMC-1248-30

**METZENBAUM-FINO**

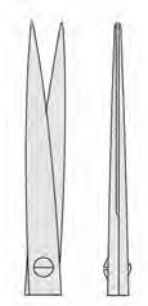
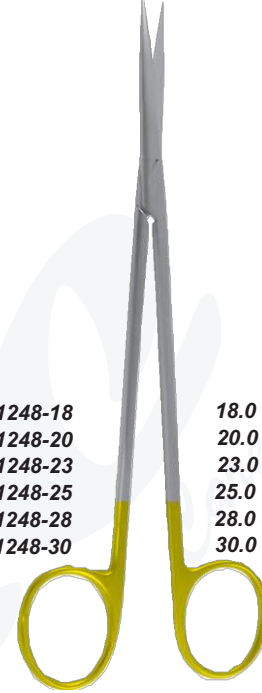

**STR-S/S**

- 18.0 cm, 7" RMC-1249-18
- 20.0 cm, 8" RMC-1249-20
- 23.0 cm, 9" RMC-1249-23
- 25.0 cm, 10" RMC-1249-25
- 28.0 cm, 11" RMC-1249-28
- 30.0 cm, 12" RMC-1249-30

**METZENBAUM-FINO**

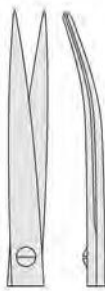

**CVD-S/S**

- 18.0 cm, 7" RMC-1250-18
- 20.0 cm, 8" RMC-1250-20
- 23.0 cm, 9" RMC-1250-23
- 25.0 cm, 10" RMC-1250-25
- 28.0 cm, 11" RMC-1250-28
- 30.0 cm, 12" RMC-1250-30

**METZENBAUM-FINO**

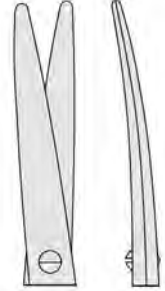
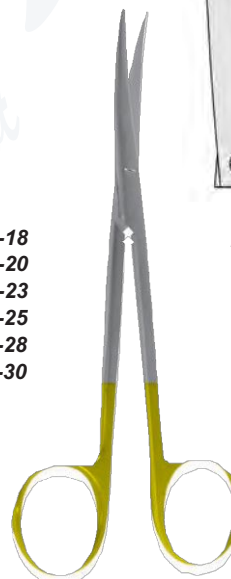

**CVD-B/B**

**RMC-1251-14**

**METZENBAUM-LAHEY**

14.0 cm, 5½"

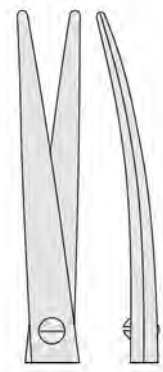

**CVD-B/B**

**RMC-1252-17**

**TOENNIS-ADSON**

17.0 cm, 6¾"

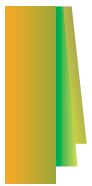

**Dissecting Scissors with tungsten carbide edges Tijeras para disección con filos de carburo tungsteno Forbici per dissezione con lame in carburo di tungsteno Präparierscheren mit Hartmetallschneiden**

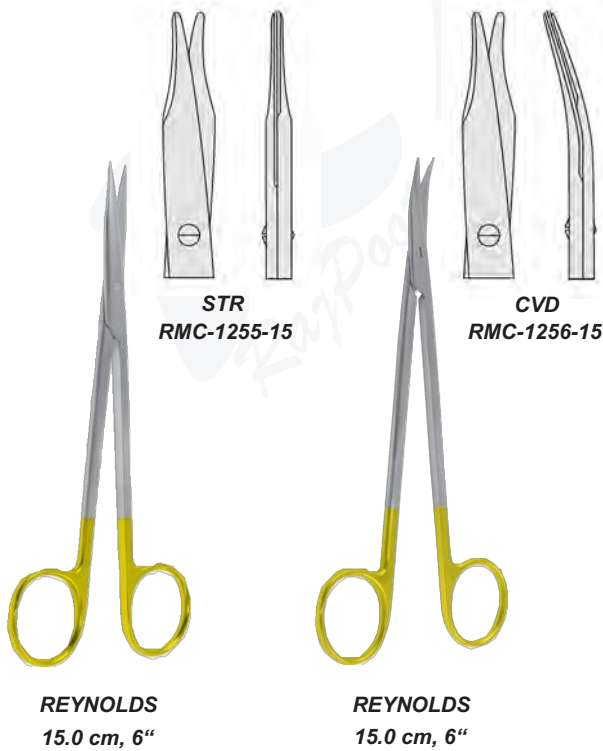
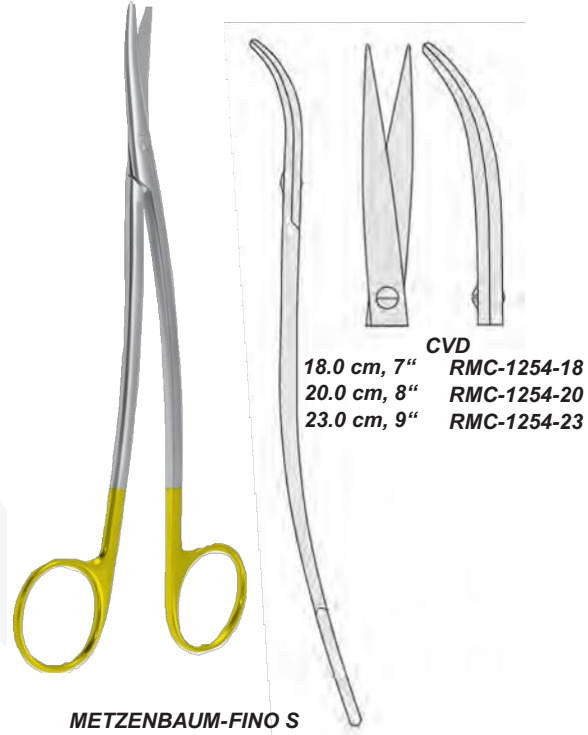
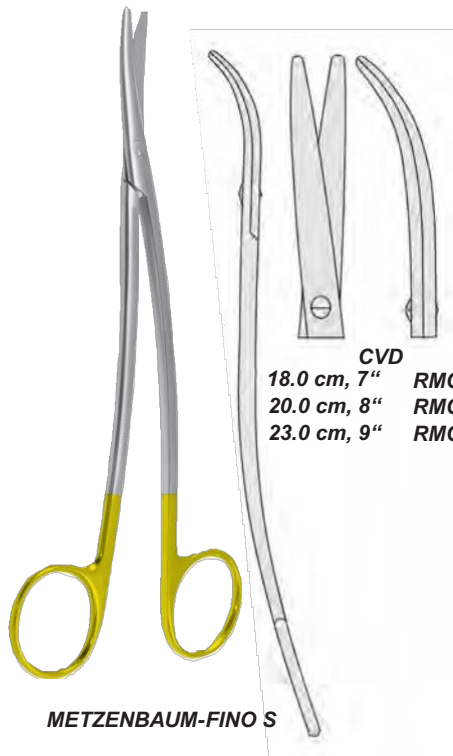



**Gynecology Scissors with tungsten carbide edges**  
**Tijeras para ginecología con filos de carburo tungsteno**  
**Forbici per ginecologia con lame in carburo di t**  
**Gynäkologische Scheren mit Hartmetallschneiden**



**SIMS**

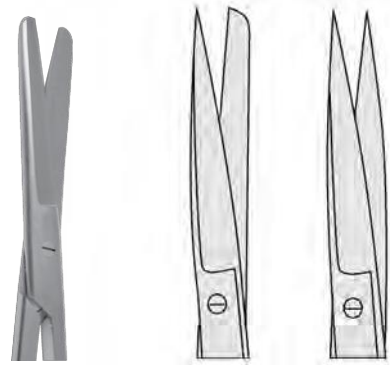

	<b>STR-B/B</b>	<b>STR-S/B</b>	<b>STR-S/S</b>
20.0 cm, 8"	<b>RMC-1259-20</b>	<b>RMC-1260-20</b>	<b>RMC-1261-20</b>
23.0 cm, 9"	<b>RMC-1259-23</b>	<b>RMC-1260-23</b>	<b>RMC-1261-23</b>



**SIMS**

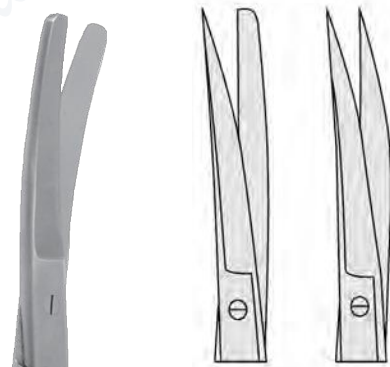

	<b>CVD-B/B</b>	<b>CVD-S/B</b>	<b>CVD-S/S</b>
20.0 cm, 8"	<b>RMC-1262-20</b>	<b>RMC-1263-20</b>	<b>RMC-1264-20</b>
23.0 cm, 9"	<b>RMC-1262-23</b>	<b>RMC-1263-23</b>	<b>RMC-1264-23</b>

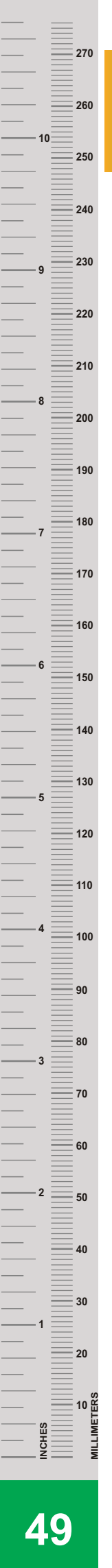



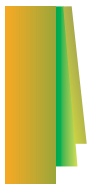

**Vascular Scissors with tungsten carbide edges**  
**Gefäßscheren mit Hartmetallschneiden**  
**Tijeras vasculares con filos de carburo tungsteno**  
**For bici vascolari con lame in carburo di tungsteno**

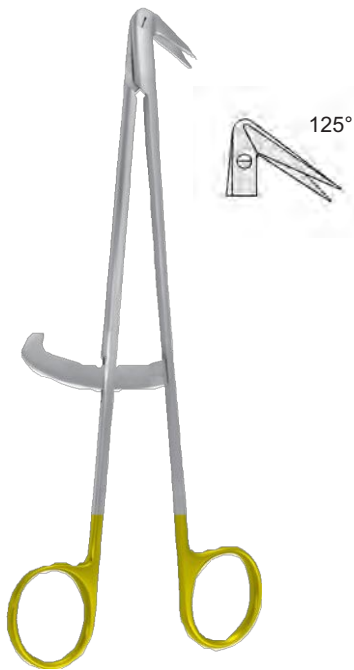

**DIETHRICH**  
**17.5 cm, 6 7/8"**  
**RMC-1265-17**

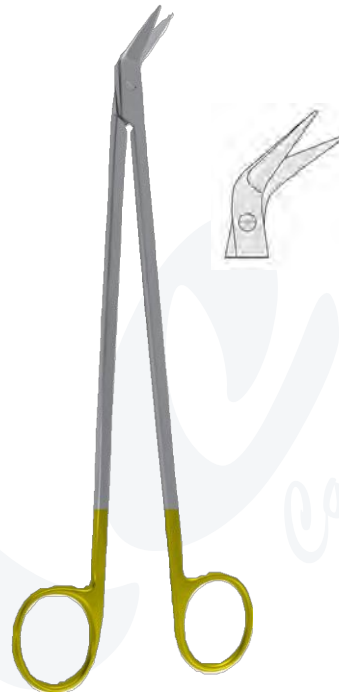

**POTTS DE MARTEL**  
**24.0 cm, 9 1/2"**  
**RMC-1266-24**



**DE BAKEY**

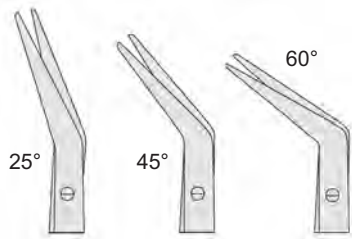

**20.0 cm, 8"** RMC-1267-20   **RMC-1268-20**   **RMC-1269-20**  
**23.0 cm, 9"** RMC-1267-23   **RMC-1268-23**   **RMC-1269-23**



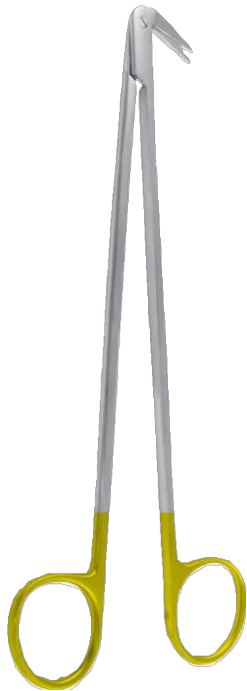

**DIETRICH-HEGEMANN**  
18.0 cm, 7"

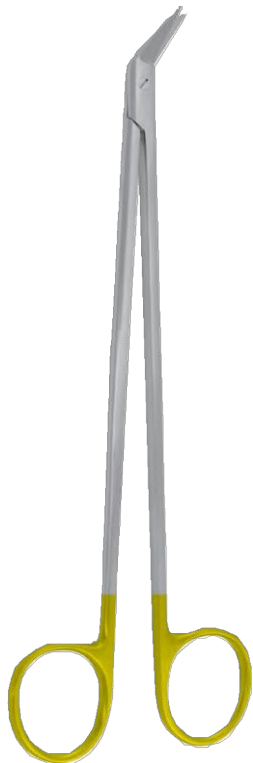
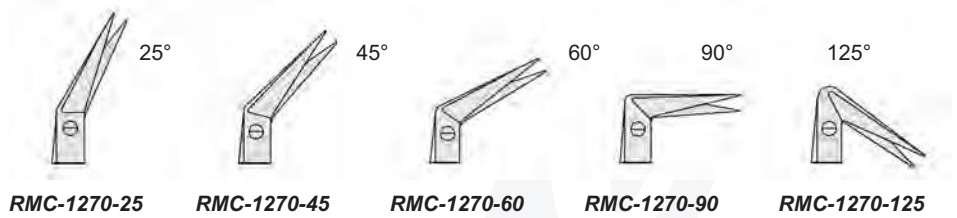

**POTTS-SMITH**  
18.0 cm, 7½"

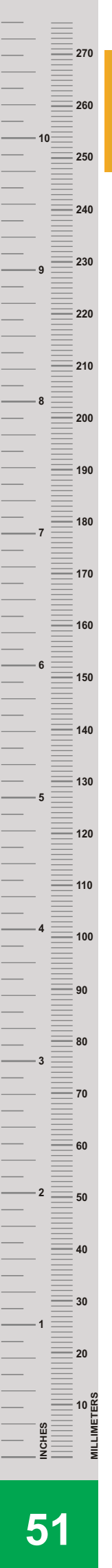
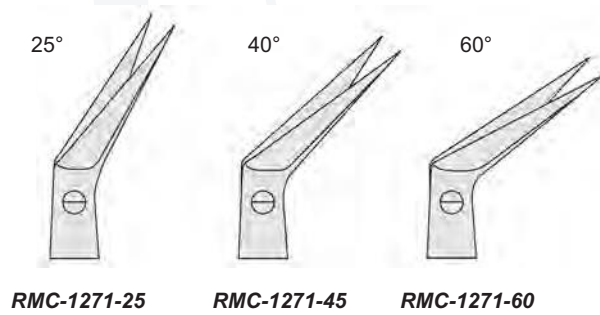

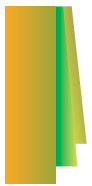

**Scissors with tungsten carbide edges**  
**Scheren mit Hartmetallschneiden**  
**Tijeras con filos de carburo tungsteno**  
**Forbici con lame in carburo di tungsteno**



**IRIS**  
11.5 cm, 4½"

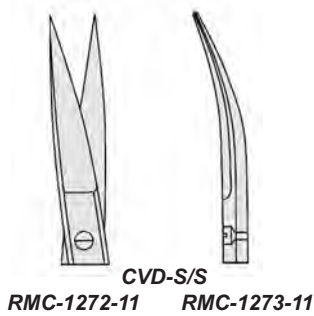

**UNIVERSAL**  
12.0 cm, 4¾"



**LISTER**  
18.0 cm, 7"  
**RMC-1275-18**

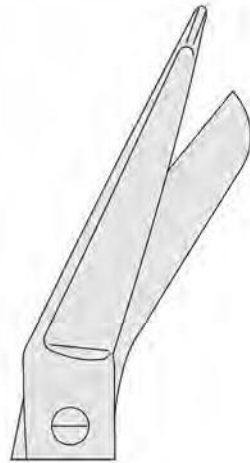

**BRUNS**  
24.0 cm, 9½"  
**RMC-1276-24**

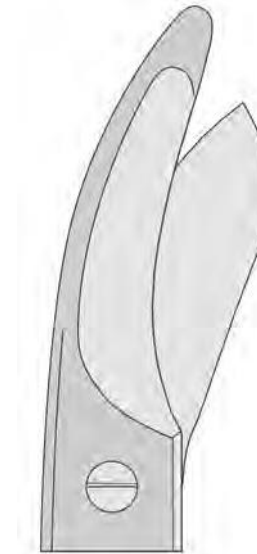

**Super-Cut Scissors**  
Tijeras Super-Cut  
Forbici Super-Cut  
Super-Cut Scheren

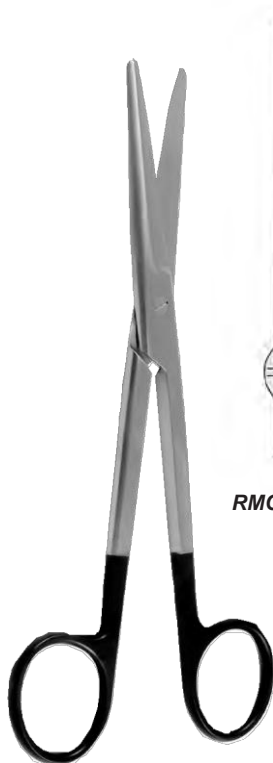

**MAYO**  
17.0 cm, 6¾"

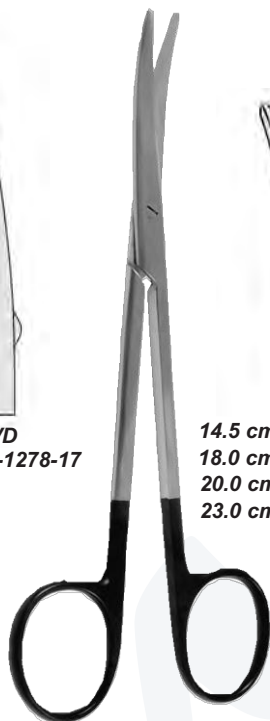
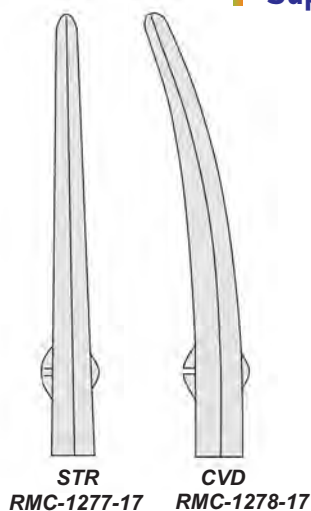

**METZENBAUM**

**CVD**  
14.5 cm, 5¾" RMC-1279-14  
18.0 cm, 7" RMC-1279-18  
20.0 cm, 8" RMC-1279-20  
23.0 cm, 9" RMC-1279-23

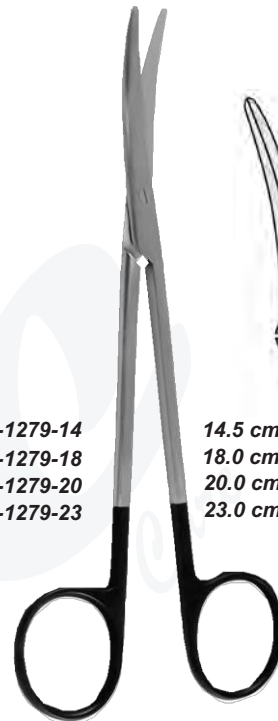

**METZENBAUM-FINO**

**CVD**  
14.5 cm, 5¾" RMC-1280-14  
18.0 cm, 7" RMC-1280-18  
20.0 cm, 8" RMC-1280-20  
23.0 cm, 9" RMC-1280-23



**KAYE FACE LIFT**

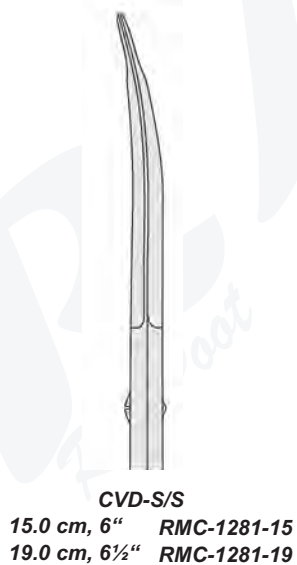

**JABALEY**  
13.0 cm, 5"  
RMC-1282-13

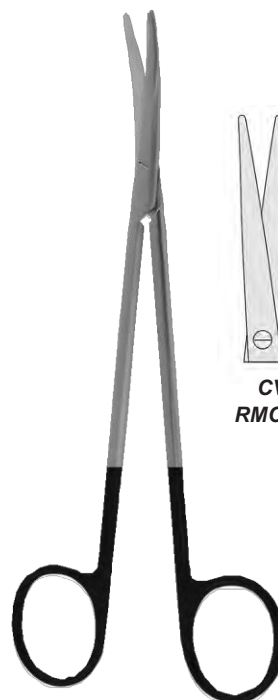

**TOENNIS-ADSON**  
17.0 cm, 6¾"

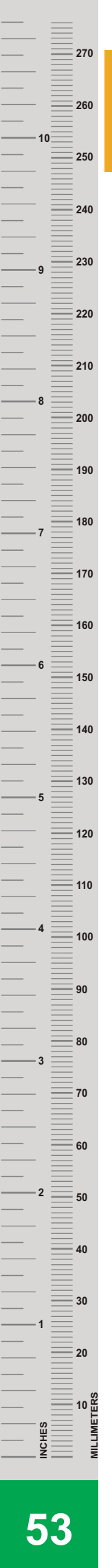
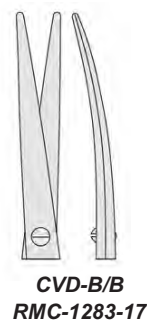

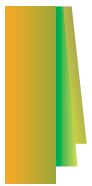

**Super-Cut Scissors**  
Tijeras Super-Cut  
Forbici Super-Cut  
Super-Cut Scheren

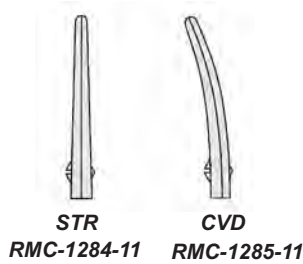
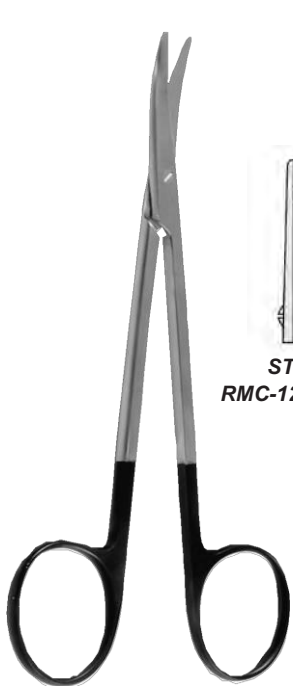
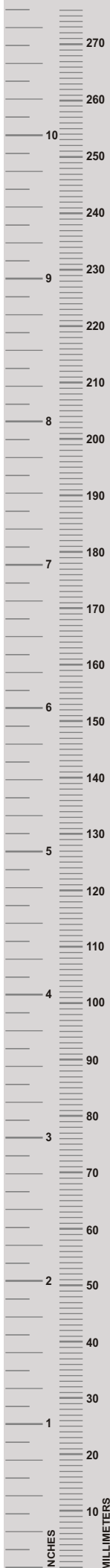

**STRABISMUS**  
11.5 cm, 4½"



**JAMISON**  
15.0 cm, 6" RMC-1286-15  
18.0 cm, 7" RMC-1286-18

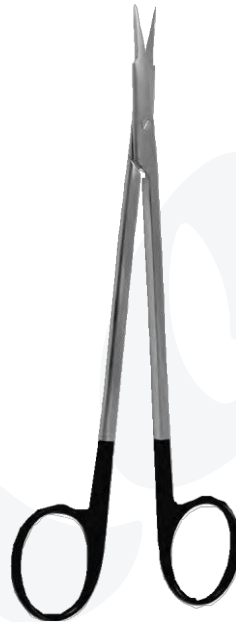

**REYNOLDS**  
12.5 cm, 5"  
RMC-1287-12



**BABY-METZENBAUM**  
11.0 cm, 4¾" RMC-1288-11  
14.5 cm, 5¾" RMC-1288-14



**IRIS**  
11.0 cm, 4¾"  
RMC-1289-11



**IRIS**  
11.0 cm, 4¾"  
RMC-1290-11



**STEVENS T ENOTOMY**  
11.0 cm, 4¾"  
RMC-1291-11



**STEVENS T ENOTOMY**  
11.0 cm, 4¾"  
RMC-1292-11

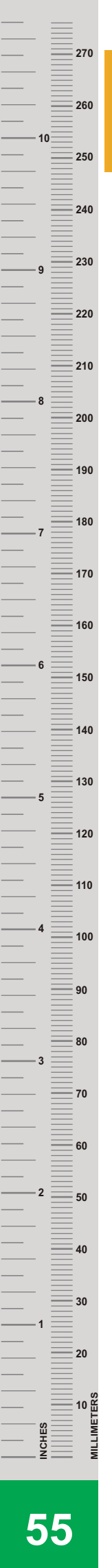

straight  
gerade

**PAR TYPE**  
12.0 cm, 4¾"  
RMC-1293-12



curved  
gebogen

**PAR TYPE**  
12.0 cm, 4¾"  
RMC-1294-12



**POTTS**  
19.0 cm, 7½"



**RMC-1295-25**



**RMC-1295-45**

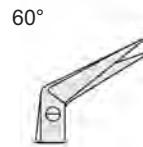

**RMC-1295-60**

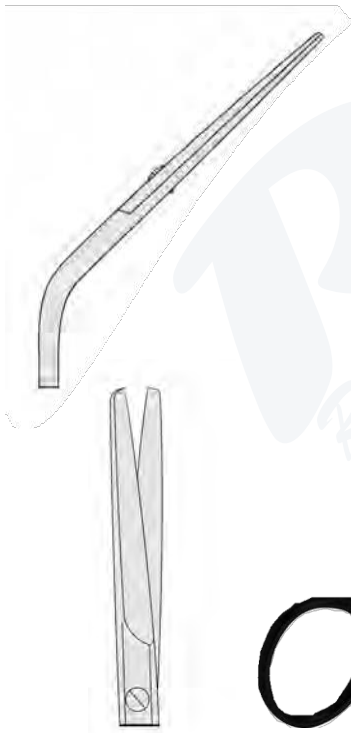

**FOMON**  
14.5 cm, 5¾"  
RMC-1296-14

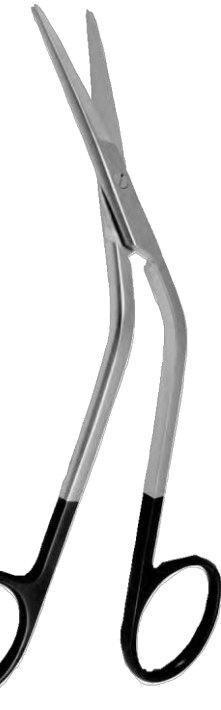
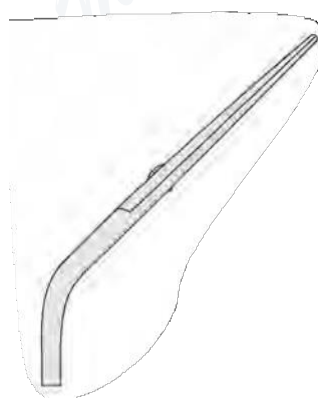

**COTTLE**  
16.5 cm, 6½"  
RMC-1297-16





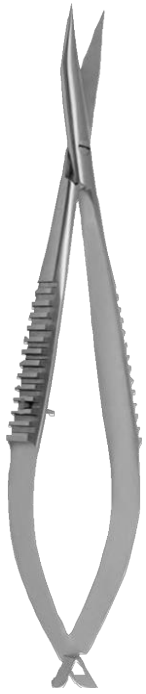
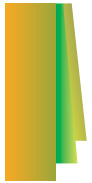

**WESTCOTT**  
11.0 cm, 4 $\frac{3}{8}$ "



**STR S/S**  
RMC-1298-11

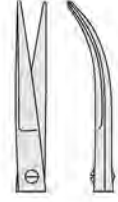

**CVD B/B**  
RMC-1299-11



**GOMEL**



**STR S/S**  
14.0 cm, 5 $\frac{1}{2}$ "  
RMC-1300-14



**CVD S/S**  
16.0 cm, 6 $\frac{1}{4}$ "  
RMC-1301-16

serrated  
dentada  
dentata  
gezahnt



**HEPP SCHEIDEL**  
14.0 cm, 5 $\frac{1}{2}$ " RMC-1302-14  
16.0 cm, 6 $\frac{1}{4}$ " RMC-1302-16

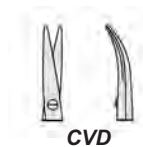

**CVD**

Micro.dissecting scissors  
Micro-tijeras de disección  
Micro-forbici per dissezione  
Mikro-Präparierscheren



**Micro Scissors  
Mikro-Scheren  
Micro-Tijeras  
Micro-Forbici**

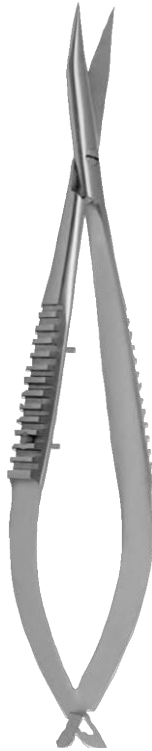

18.5 cm, 7¼"



**STEVENS**

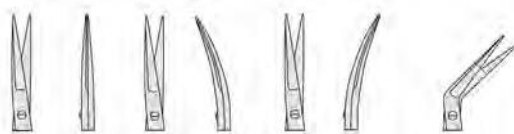

**STR**      **CVD**      **SLIGHTLY-CVD**      **HEAVILY-CVD**  
 18.5 cm, 7¼" RMC-1306-01 RMC-1307-01 RMC-1308-01 RMC-1309-01  
 22.5 cm, 8¾" RMC-1306-02 RMC-1307-02 RMC-1308-02 RMC-1309-02



**STR**      **CVD**  
 18.5 cm, 7¼" RMC-1310-01 RMC-1311-01  
 22.5 cm, 8¾" RMC-1310-02 RMC-1311-02



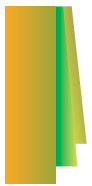

**Micro Scissors, Micro Dissecting Scissors  
Micro-Tijeras, Micro Tijeras de disección  
Micro-Forbici, Micro-Forbici per dissezione  
Mikro-Scheren, Mikro-Scheren,**



18.0 cm, 7"



RMC-1312-25



RMC-1312-45

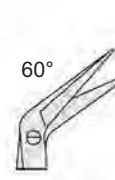

RMC-1312-60

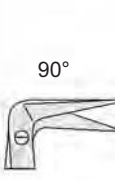

RMC-1312-90



RMC-1312-12



RMC-1313-25



RMC-131345



RMC-1313-60



RMC-1313-90



RMC-1313-12



15.0 cm, 6"  
RMC-1314-15



15.0 cm, 6"  
RMC-1315-15



serrated  
dentada  
dentata  
gezahnt



15.0 cm, 6"  
RMC-1316-15



15.0 cm, 6"  
RMC-1317-18





**Micro Adventitia Scissors**  
**Mikro-Adventitiascheren**  
**Micro-Tijeras Adventitia**  
**Micro-Forbici Adventitia**



**15.0 cm, 6"**  
**RMC-1318-15**



**15.0 cm, 6"**  
**RMC-1319-15**



**serrated**  
**dentata**  
**dentata**  
**gezahnt**



**15.0 cm, 6"**  
**RMC-1320-15**

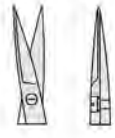

**18.0 cm, 7"**  
**RMC-1321-15**

