

Forceps
Klemmen
Pinas
Pinze





DIEFFENBACH



STR
 3.5 cm, 1½"
RMC-1480-03



CVD
 5.0 cm, 2"
RMC-1480-05



HESS
RMC-1481-01



HESS
RMC-1481-02



JOHNS-HOPKINS



STR
 3.8 cm, 1½" **RMC-1482-04**
 5.0 cm, 2" **RMC-1482-05**
 6.3 cm, 2½" **RMC-1482-06**
 7.3 cm, 3" **RMC-1482-07**
 9.3 cm, 3½" **RMC-1482-09**



CVD
RMC-1483-04
RMC-1483-05
RMC-1483-06
RMC-1483-07
RMC-1483-09



JOHNS-HOPKINS
 23.0 cm, 9"
RMC-1484-23

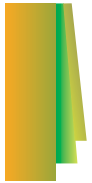

Bulldog Clamps
Bulldogklemmen
Clamps Bulldog
Pinze Bulldog

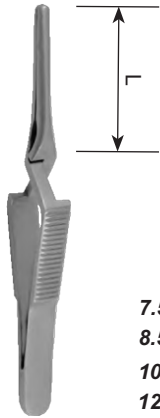

with non-traumatic serration
con bocas atraumáticas
con presa atraumatica
с атравматичной зазубренностью
mit atraumatischer Riefung

L

7.5 cm, 3"	RMC-1485-07	2.5 cm, 1"
8.5 cm, 3 1/4"	RMC-1485-08	3.5 cm, 1 1/4"
10.5 cm, 4 1/8"	RMC-1485-10	5.0 cm, 2"
12.0 cm, 4 3/4"	RMC-1485-12	6.8 cm, 2 3/4"

DE BAKEY

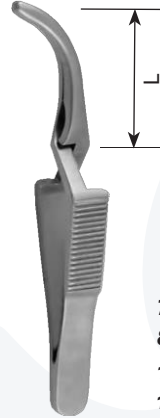

with non-traumatic serration
con bocas atraumáticas
con presa atraumatica
с атравматичной зазубренностью
mit atraumatischer Riefung

L

7.5 cm, 3"	RMC-1486-07	2.5 cm, 1"
8.5 cm, 3 1/4"	RMC-1486-08	3.5 cm, 1 1/4"
10.5 cm, 4 1/8"	RMC-1486-10	5.0 cm, 2"
12.0 cm, 4 3/4"	RMC-1486-12	6.8 cm, 2 3/4"

DE BAKEY



TITANIUM
3.5 cm, 1 1/8"
vena RMC-1487-35
arteria



straight
recto
retto
gerade

TITANIUM
4.0 cm, 1 5/8"
vena RMC-1488-40
arteria



TITANIUM
3.5 cm, 1 1/8"
vena RMC-1489-35
arteria



curved
curvo
curvo
gebogen

TITANIUM
4.0 cm, 1 5/8"
vena RMC-1490-40
arteria

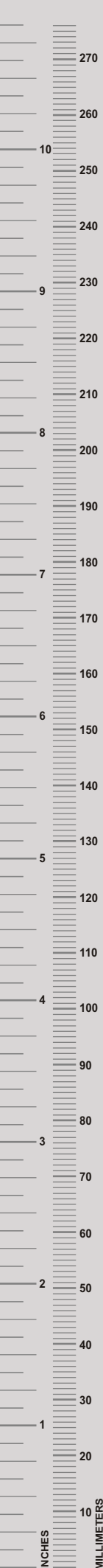

Bulldog Clamps, Intestinal and Tissue Grasping Forceps
Clamps Bulldog, Pinzas intestinales y para tejidos
Pinze Bulldog, Pinze da presa per intestino e tessuti
Bulldogklemmen, Darm- und Gewebefazangen

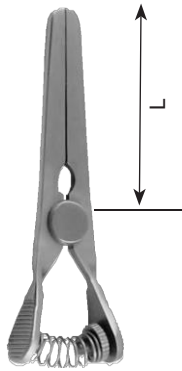

GLOVER

6.8 cm, 2¾"	RMC-1491-07	L	3.3 cm, 1⅜"
9.6 cm, 3¾"	RMC-1491-08		5.0 cm, 2"
11.7 cm, 4¾"	RMC-1491-11		6.9 cm, 2¾"

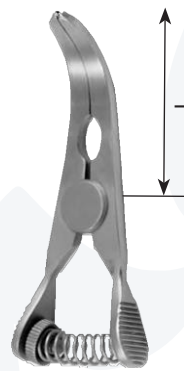

GLOVER

6.5 cm, 2½"	RMC-1492-06	L	3.3 cm, 1⅜"
9.1 cm, 3½"	RMC-1492-09		5.0 cm, 2"
11.0 cm, 4⅝"	RMC-1492-11		6.9 cm, 2¾"



CHAPUT
 13.0 cm, 5"
 RMC-1493-13



TUFFIER
 13.0 cm, 5"
 RMC-1494-13



COLLIN
 16.0 cm, 6¼"
 RMC-1495-16

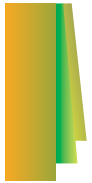

Intestinal and Tissue Grasping Forceps
Darm- und Gewebefäßzangen
Pinzas intestinales y para tejidos
Pinze da presa per intestino e tessuti

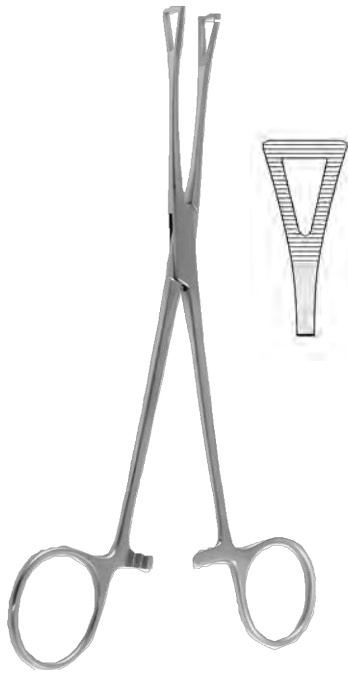

PENNINGTON
15.5 cm, 6" RMC-1496-15
20.0 cm, 8" RMC-1496-20



25.0 cm, 9¾"
RMC-1497-25



27.0 cm, 10½"
RMC-1497-27

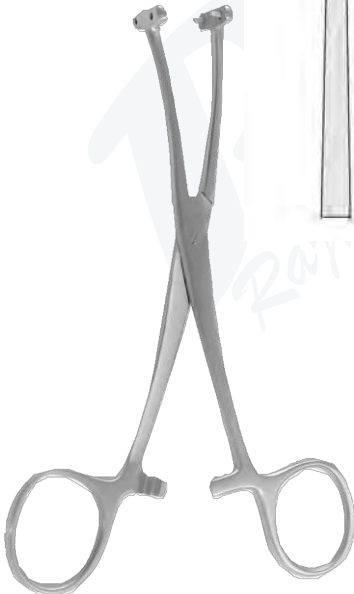

MARTEL
14.0 cm, 5½"
RMC-1498-14



WILLET-MARTEL
19.0 cm, 7½"
RMC-1499-19



**Haemostatic Forceps
Arterienklemmen
Pinzas hemostáticas
Pinze emostatiche**



PRATT
15.0 cm, 6"
RMC-1500-15



FERGUSSON

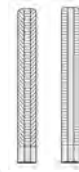

STR
16.0 cm, 6¼" RMC-1501-16
20.0 cm, 8" RMC-1501-20

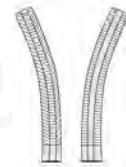

CVD
16.0 cm, 6¼" RMC-1502-16
20.0 cm, 8" RMC-1502-20



CARREL
10.0 cm, 4"
RMC-1503-10

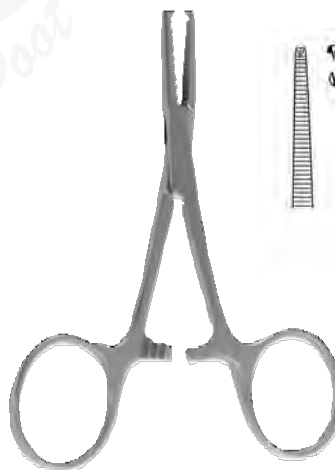

TERRIER
10.0 cm, 4"
RMC-1504-10



KROENLEIN
13.0 cm, 5"
RMC-1505-13



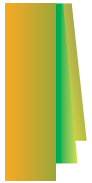

Haemostatic Forceps Arterienklemmen Pinzas hemostáticas

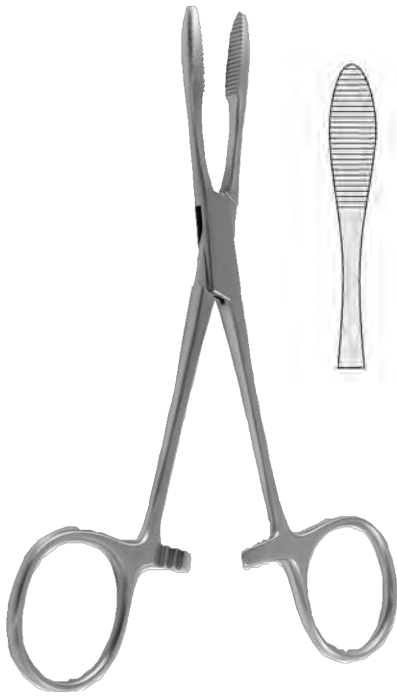

PEAN
14.0 cm, 5½" RMC-1506-14
16.0 cm, 6¼" RMC-1506-16

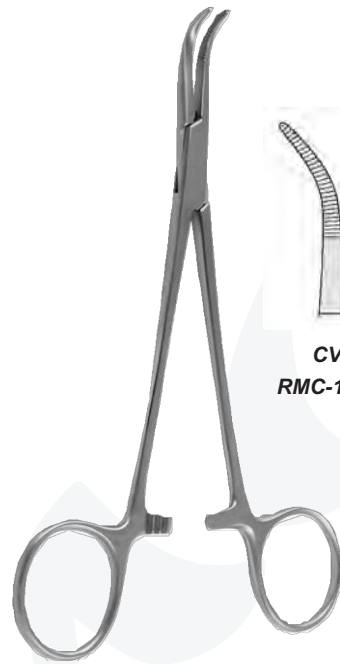

BABY-MIXTER
14.0 cm, 5½"

CVD
RMC-1507-01



STRONGLY-CVD
RMC-1507-02



SPENCER-WELLS

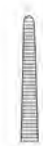

STR



CVD

- | | | |
|-------------|-------------|-------------|
| 13.0 cm, 5" | RMC-1508-13 | RMC-1509-13 |
| 15.0 cm, 6" | RMC-1508-15 | RMC-1509-15 |
| 18.0 cm, 7" | RMC-1508-18 | RMC-1509-18 |
| 20.0 cm, 8" | RMC-1508-20 | RMC-1509-20 |

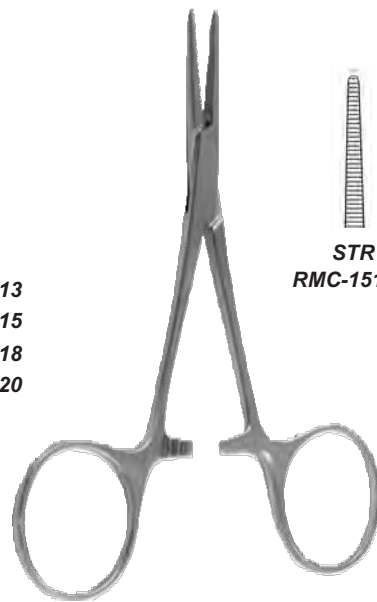

HARTMANN
10.0 cm, 4"

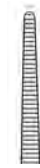

STR
RMC-1510-10



CVD
RMC-1511-10

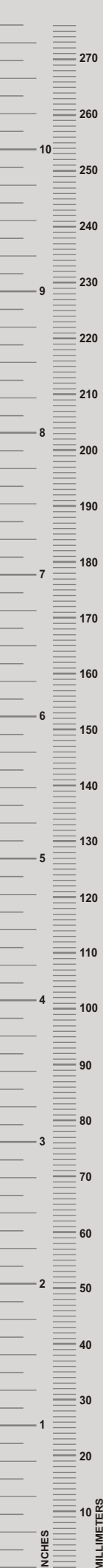

Haemostatic Forceps Arterienklemmen Pinzas hemostáticas Pinze emostatiche



PROVINCENCE-HOSPITAL
14.0 cm, 5½"

STR
RMC-1512-14



CVD
RMC-1513-14



HALSTED-MOSQUITO

STR
12.5 cm, 5"
14.0 cm, 9¼"

CVD
RMC-1515-12
RMC-1515-14
1 x 2

STR
12.5 cm, 5"
14.0 cm, 9¼"

CVD
RMC-1517-12
RMC-1517-14
1 x 2



HALSTED-MOSQUITO

STR
18.0 cm, 7"
RMC-1518-18

STR
21.0 cm, 8¼"
RMC-1518-21

CVD
18.0 cm, 7"
RMC-1519-18

CVD
21.0 cm, 8¼"
RMC-1519-21

1 x 2



STR
18.0 cm, 7"
RMC-1520-18

1 x 2



STR
21.0 cm, 8¼"
RMC-1520-21

1 x 2



CVD
18.0 cm, 7"
RMC-1521-18

1 x 2



CVD
21.0 cm, 8¼"
RMC-1521-21

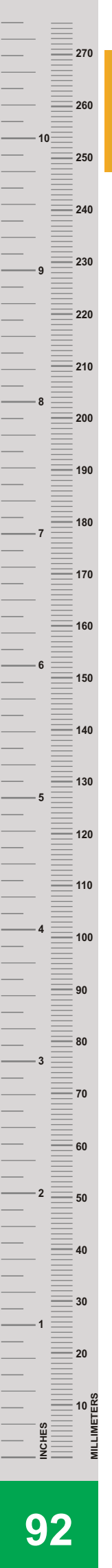

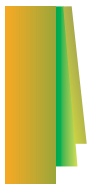

**Haemostatic Forceps
Arterienklemmen
Pinzas hemostáticas
Pinze emostatiche**

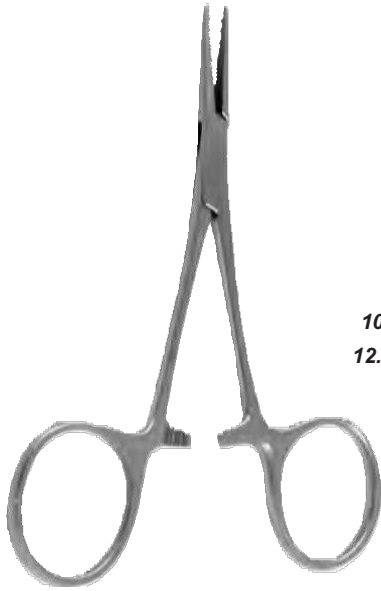

MICRO-MOSQUITO



STR



CVD

1 x 2



STR

1 x 2



CVD

10.0 cm, 4" RMC-1522-10 RMC-1523-10 RMC-1524-10 RMC-1525-10
12.0 cm, 4 1/4" RMC-1522-12 RMC-1523-12 RMC-1524-12 RMC-1525-12



KELLY
14.0 cm, 5 1/2"



STR
RMC-1526-14



CVD
RMC-1527-14



KELLY-RANKIN
16.0 cm, 6 1/4"



STR
RMC-1528-16



CVD
RMC-1529-16

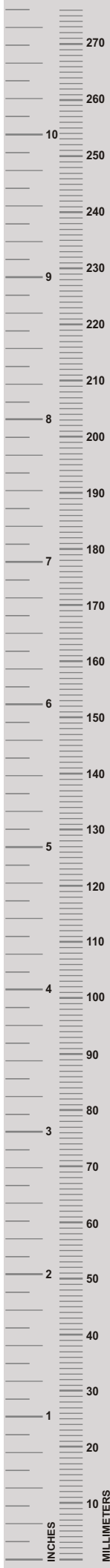



LERICHE
 15.0 cm, 6"



BABY-OVERHOLT
 13.5 cm, 5 1/4"

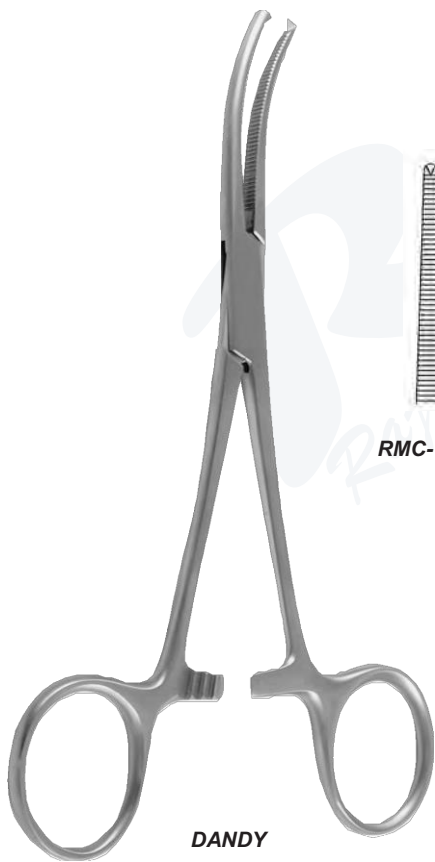
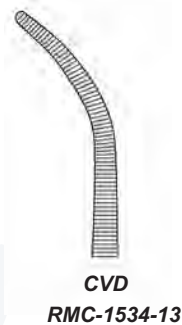

DANDY
 14.0 cm, 5 1/2"



CRILE
 14.0 cm, 5 1/2"

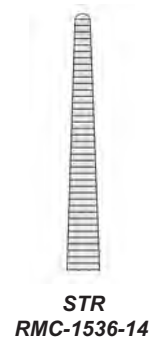

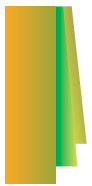

**Haemostatic Forceps
Arterienklemmen
Pinzas hemostáticas
Pinze emostatiche**



DIXON-LOVELACE
15.0 cm, 6"

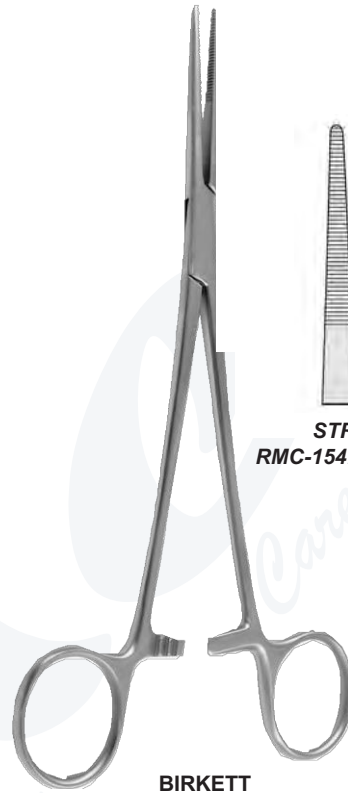
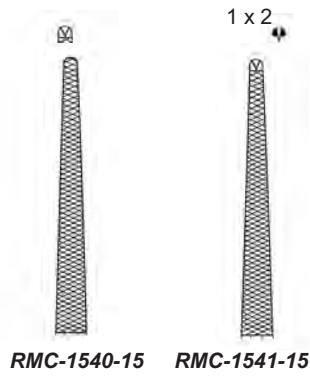

BIRKETT
19.0 cm, 7½"

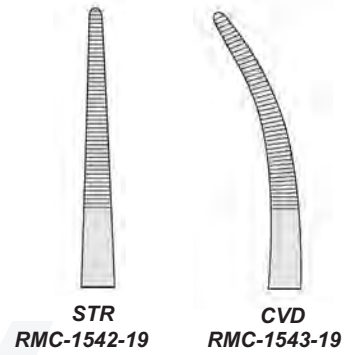

CRILE-RANKIN
16.0 cm, 6¼"

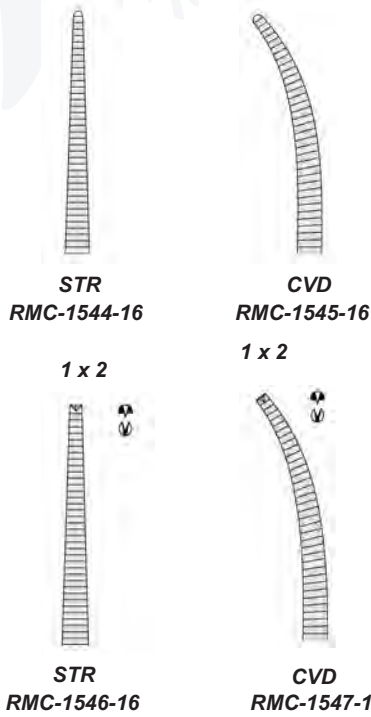

**Haemostatic Forceps
Arterienklemmen
Pinzas hemostáticas
Pinze emostatiche**

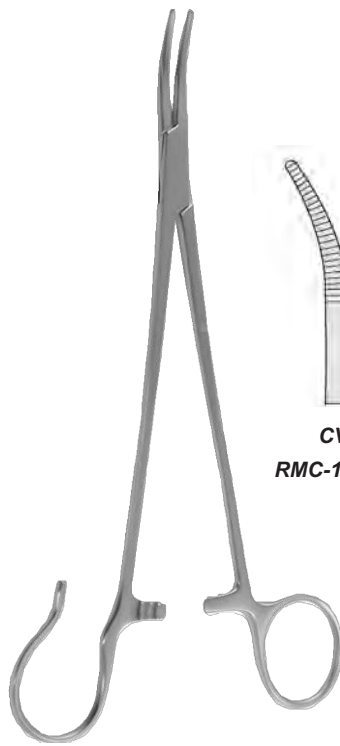

SCHNIDT
19.0 cm, 7½"



CVD
RMC-1548-19



STRONGLY-CVD
RMC-1549-19

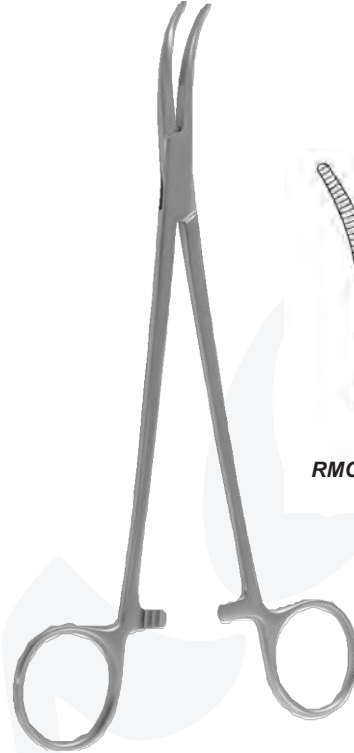

SCHNIDT-SAWTELL
19.0 cm, 7½"



CVD
RMC-1550-19



STRONGLY-CVD
RMC-1551-19



ADSON
18.5 cm, 7¼"

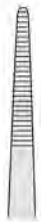

STR
RMC-1552-01



CVD
RMC-1553-02

1 x 2

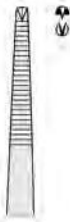

STR
RMC-1554-03

1 x 2



CVD
RMC-1555-04



CRAFOORD
24.0 cm, 9½"
RMC-1556-24

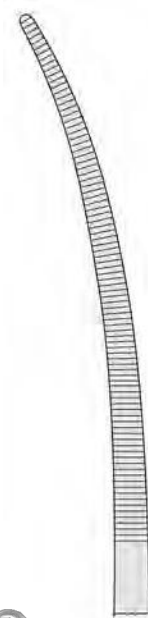

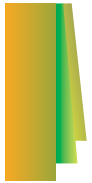

**Haemostatic Forceps
Arterienklemmen
Pinzas hemostáticas
Pinze emostatiche**

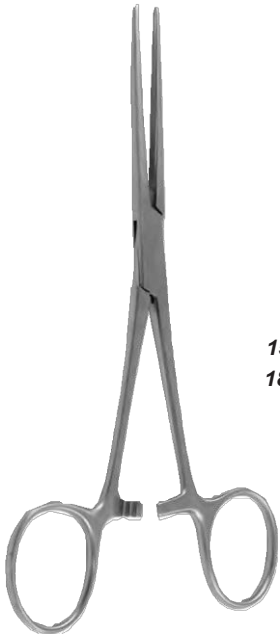

BAINBRIDGE

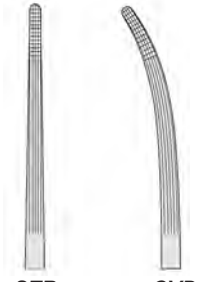

STR **CVD**
 15.0 cm, 6" RMC-1557-15 RMC-1558-15
 18.5 cm, 7 1/4" RMC-1557-18 RMC-1558-18



ROCHESTER-CARMALT

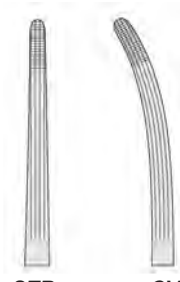

STR **CVD**
 16.0 cm, 6 1/4" RMC-1559-16 RMC-1560-16
 20 cm, 8" RMC-1559-20 RMC-1560-18

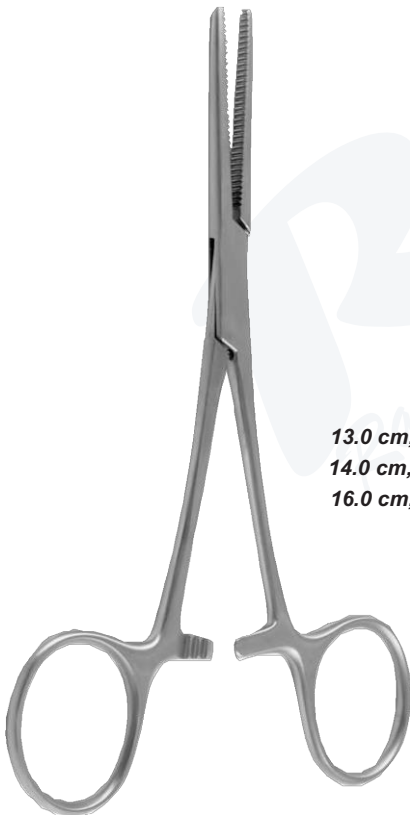

PEAN DELICATE

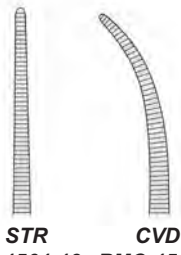

STR **CVD**
 13.0 cm, 5" RMC-1561-13 RMC-1562-13
 14.0 cm, 5 1/2" RMC-1561-14 RMC-1562-14
 16.0 cm, 6 1/4" RMC-1561-16 RMC-1562-16

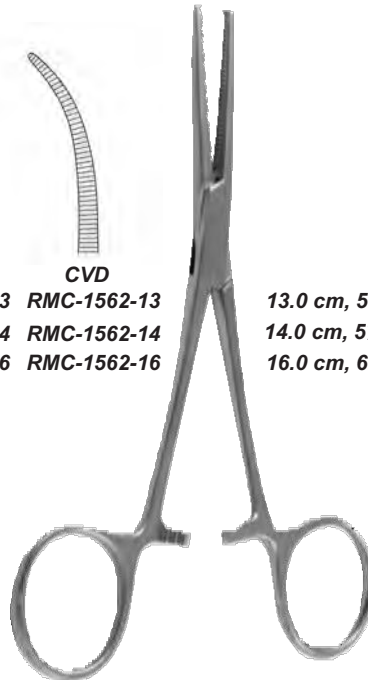

KOCHER DELICATE

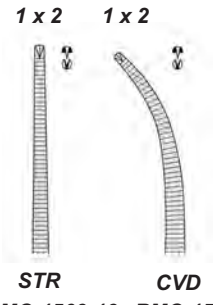

STR **CVD**
 13.0 cm, 5" RMC-1563-13 RMC-1564-13
 14.0 cm, 5 1/2" RMC-1563-14 RMC-1564-14
 16.0 cm, 6 1/4" RMC-1563-16 RMC-1564-16



Haemostatic Forceps Arterienklemmen Pinzas hemostáticas Pinze emostatiche

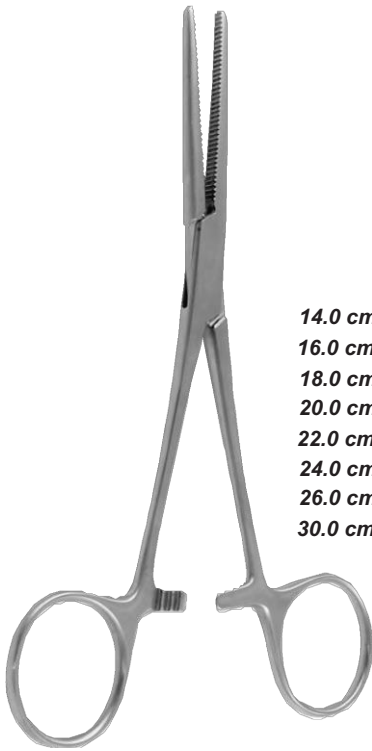

ROCHESTER-PEAN

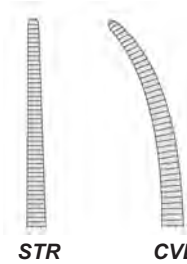

STR CVD

- | | | |
|---------------|-------------|-------------|
| 14.0 cm, 5½" | RMC-1565-14 | RMC-1566-14 |
| 16.0 cm, 6½" | RMC-1565-16 | RMC-1566-16 |
| 18.0 cm, 7" | RMC-1565-18 | RMC-1566-18 |
| 20.0 cm, 8" | RMC-1565-20 | RMC-1566-20 |
| 22.0 cm, 8⅝" | RMC-1565-22 | RMC-1566-22 |
| 24.0 cm, 9½" | RMC-1565-24 | RMC-1566-24 |
| 26.0 cm, 10¼" | RMC-1565-26 | RMC-1566-26 |
| 30.0 cm, 12" | RMC-1565-30 | RMC-1566-30 |

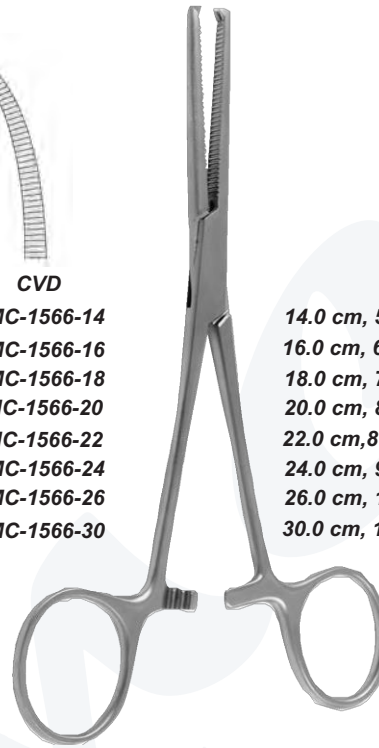

KOCHER-OCHSNER

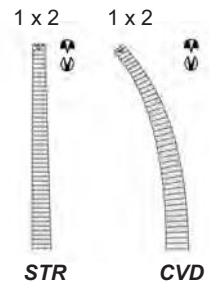

STR CVD

- | | | |
|---------------|-------------|-------------|
| 14.0 cm, 5½" | RMC-1567-14 | RMC-1568-14 |
| 16.0 cm, 6½" | RMC-1567-16 | RMC-1568-16 |
| 18.0 cm, 7" | RMC-1567-18 | RMC-1568-18 |
| 20.0 cm, 8" | RMC-1567-20 | RMC-1568-20 |
| 22.0 cm, 8⅝" | RMC-1567-22 | RMC-1568-22 |
| 24.0 cm, 9½" | RMC-1567-24 | RMC-1568-24 |
| 26.0 cm, 10¼" | RMC-1567-26 | RMC-1568-26 |
| 30.0 cm, 12" | RMC-1567-30 | RMC-1568-30 |



BENGOLEA

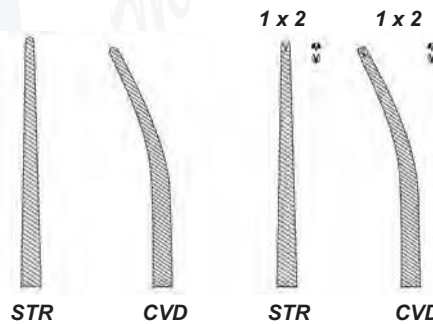

STR CVD STR CVD

- | | | | | |
|---------------|-------------|-------------|-------------|-------------|
| 20.0 cm, 8" | RMC-1569-20 | RMC-1570-20 | RMC-1571-20 | RMC-1572-20 |
| 26.0 cm, 10¼" | RMC-1569-26 | RMC-1570-26 | RMC-1571-26 | RMC-1572-26 |

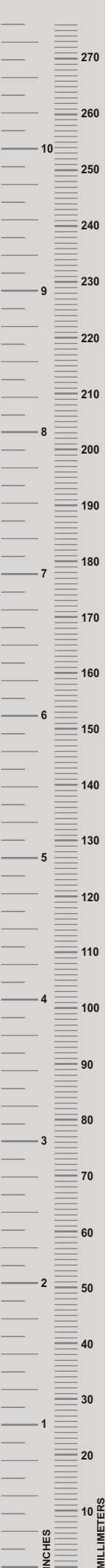

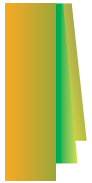

**Haemostatic Forceps
Arterienklemmen
Pinzas hemostáticas
Pinze emostatiche**



HEISS
20.0 cm, 8"



STR
RMC-1573-20



CVD
RMC-1574-20

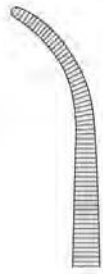

STRONGLY-CVD
RMC-1575-20



ROBERTS
22.0 cm, 8⁵/₈"



STR
RMC-1576-22



CVD
RMC-1577-22

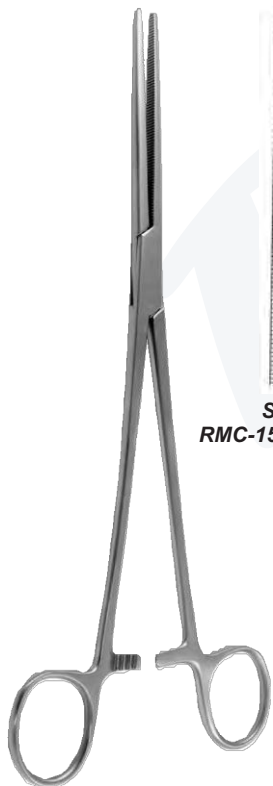

SAROT
24.0 cm, 9¹/₂"



STR
RMC-1578-24



CVD
RMC-1579-24



NEGUS
19.0 cm, 7¹/₂"

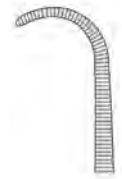

CVD
RMC-1580-19

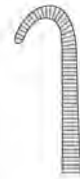

STRONGLY-CVD
RMC-1581-19





14.0 cm, 5½"
RMC-1582-14



14.0 cm, 5½"
RMC-1583-14



BABY-ADSON

MICRO-ADSON



BABY-MIXTER
18.0 cm, 7"
RMC-1584-18

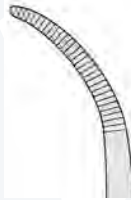

OVERHOLT-MIXTER
21.0 cm, 8¼"
RMC-1585-21

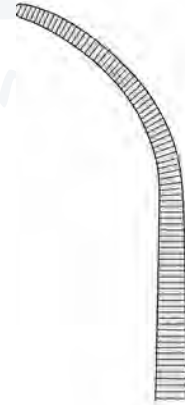

JOHNS HOPKINS
20.0 cm, 8"
RMC-1586-20

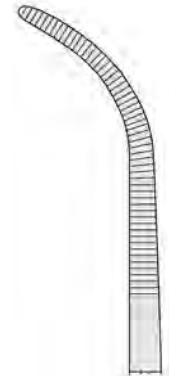

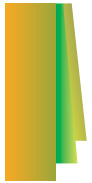

Dissecting and Ligature Forceps
Präparier- und Ligaturklemmen
Pinzas de disección y ligaduras
Pinze per preparazioni e legature



OVERHOLT-ANGULAR

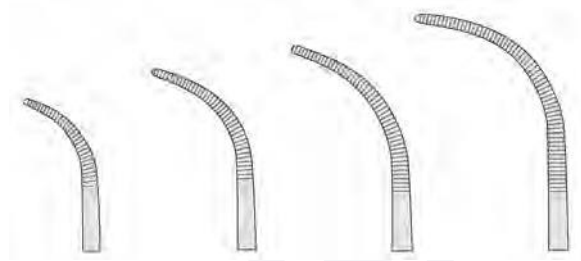

18.5 cm, 7¼"	20.0 cm, 8"	21.0 cm, 8¼"	21.5 cm, 8½"
RMC-1587-01	RMC-1587-02	RMC-1587-03	RMC-1587-04



RUMEL
23.0 cm, 9"

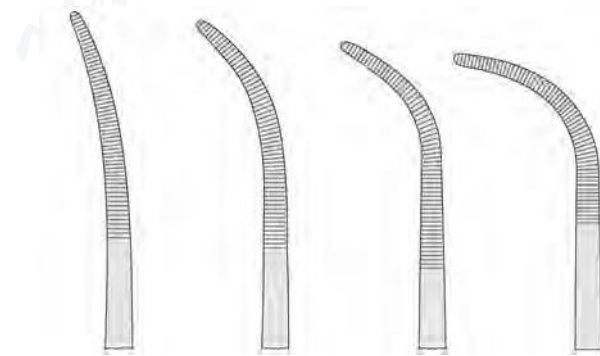

SLIGHTLY-CVD	CVD	STRONGLY-CVD	HEAVILY-CVD
RMC-1588-01	RMC-1588-02	RMC-1588-03	RMC-1588-04



Dissecting and Ligature Forceps Präparier- und Ligaturklemmen Pinzas de disección y ligaduras Pinze per preparazioni e legature



OVERHOLT-GEISSENDOERFER

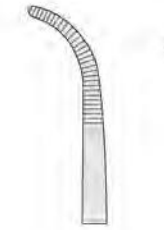

HEAVILY-CVD
20.5 cm, 7¾"
RMC-1589-01



CVD
20.0 cm, 7½"
RMC-1589-02

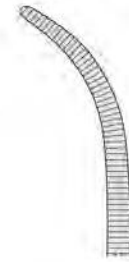

CVD
21.5 cm, 8¼"
RMC-1589-03



CVD
22.5 cm, 8¾"
RMC-1589-04

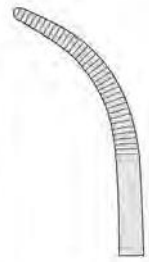

CVD
21.5 cm, 8½"
RMC-1589-05

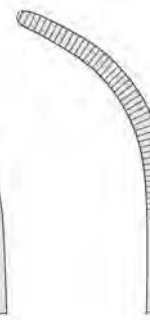

CVD
22.0 cm, 8¾"
RMC-1589-06



SLIGHTLY-CVD
22.0 cm, 8¾"
RMC-1589-07



HEAVILY-CVD
27.0 cm, 10¾"
RMC-1590-01



CVD
26.0 cm, 10¼"
RMC-1590-02

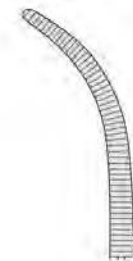

CVD
27.0 cm, 10¾"
RMC-1590-03



CVD
27.0 cm, 10¾"
RMC-1590-04



CVD
27.5 cm, 10¾"
RMC-1590-05



CVD
28.0 cm, 11"
RMC-1590-06



SLIGHTLY-CVD
28.0 cm, 11"
RMC-1690-07

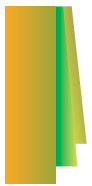

Dissecting and Ligature Forceps
Präparier- und Ligaturklemmen
Pinzas de disección y ligaduras
Pinze per preparazioni e legature



TOENNIS

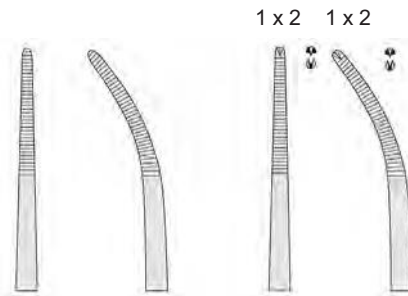

STR CVD STR CVD

21.0 cm, 8¼" RMC-1591-21 RMC-1592-21 RMC-1593-21 RMC-1594-21
 26.0 cm, 10¼" RMC-1591-26 RMC-1592-26 RMC-1593-26 RMC-1594-26



KELLY

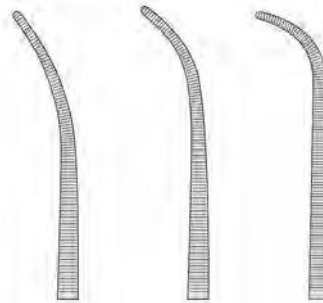

SLIGHTLY-CVD HEAVILY-CVD STRONGLY-CVD

19.0 cm, 7¼" RMC-1595-19 RMC-1596-19 RMC-1597-19
 22.0 cm, 8¾" RMC-1595-22 RMC-1596-22 RMC-1597-22
 24.0 cm, 9¼" RMC-1595-24 RMC-1596-24 RMC-1597-24



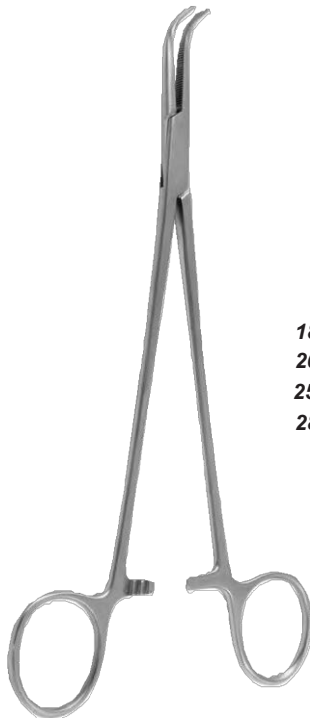

MINI-GEMINI

18.0 cm, 7" RMC-1598-18
 20.0 cm, 8" RMC-1598-22
 25.0 cm, 9" RMC-1598-25
 28.0 cm, 11" RMC-1598-28



GEMINI

14.0 cm, 5½" RMC-1599-14
 16.0 cm, 6¼" RMC-1599-16
 18.0 cm, 7" RMC-1599-18
 20.0 cm, 8" RMC-1599-20
 23.0 cm, 9" RMC-1599-23
 25.0 cm, 9¾" RMC-1599-25
 28.0 cm, 7" RMC-1599-28



KANTROWITZ

20.0 cm, 8" RMC-1600-20
 24.0 cm, 9½" RMC-1600-24
 28.0 cm, 11" RMC-1600-28



WIKSTROEM

19.0 cm, 7½" RMC-1601-19
 21.0 cm, 8¼" RMC-1601-21
 24.0 cm, 9½" RMC-1601-24

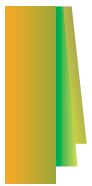

**Dissecting and Ligature Forceps
Präparier- und Ligaturklemmen
Pinzas de disección y ligaduras
Pinze per preparazioni e legature**



MIXTER
15.5 cm, 6" RMC-1602-15
19.0 cm, 7½" RMC-1602-19



MIXTER-O'SHAUGHNESSY
15.5 cm, 6" RMC-1603-15
19.0 cm, 7½" RMC-1603-19



MIXTER
22.0 cm, 8½"
RMC-1604-22



MIXTER
23.0 cm, 9"
RMC-1605-23



ZENKER

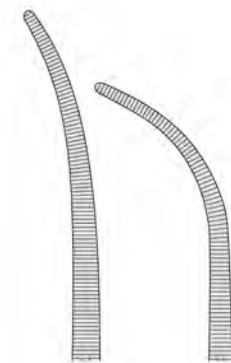

CVD **STRONGLY-CVD**
30.0 cm, 12" 29.0 cm, 11"
RMC-1606-01 RMC-1606-02



Pinze per preparazioni e legature

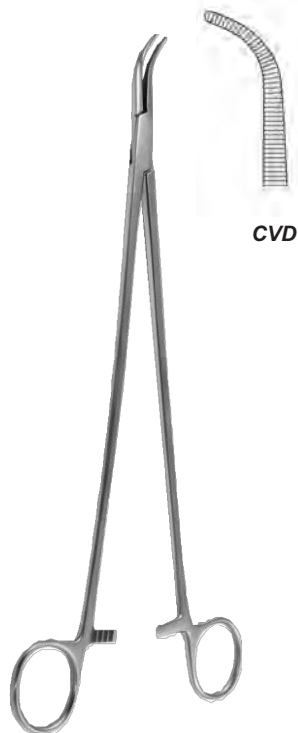

LAWRENCE
27.5 cm, 10¾"
RMC-1607-28

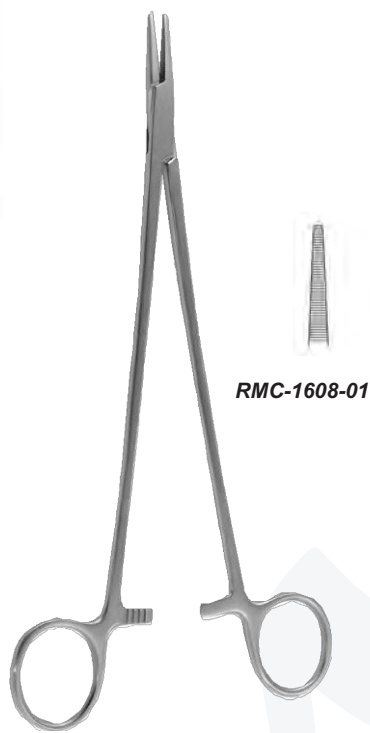

HOSEMANN
21.0 cm, 8¼"

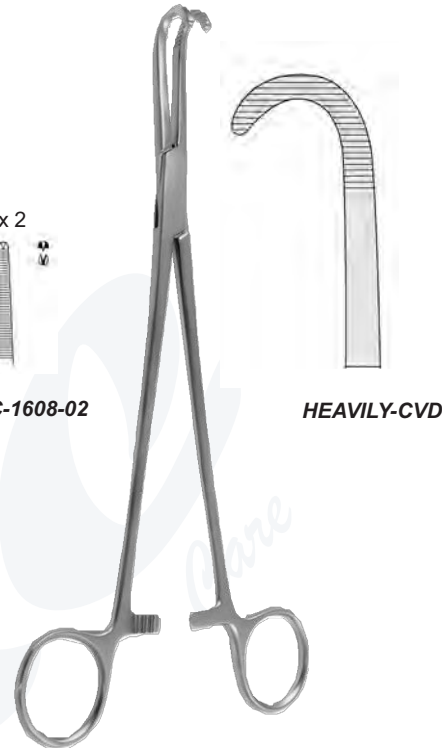

DESJARDINS
21.0 cm, 8¼"
RMC-1609-21



MIXTER
22.0 cm, 8¾" RMC-1610-22
25.0 cm, 9½" RMC-1610-25
28.0 cm, 11" RMC-1610-28

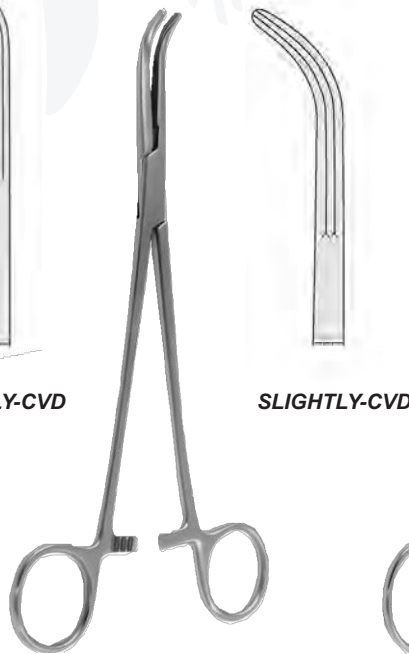

LAHEY
19.0 cm, 7½" RMC-1611-19
23.0 cm, 9" RMC-1611-23

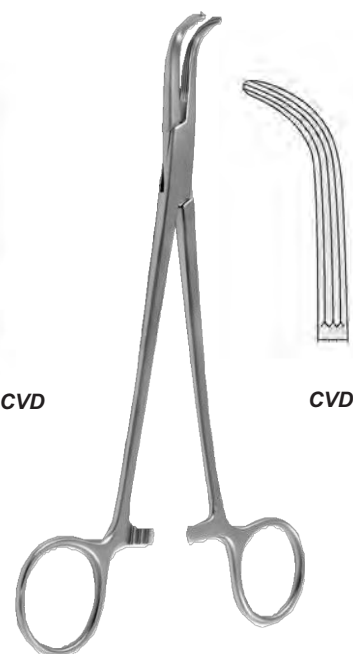

LOWER
18.0 cm, 7"
RMC-1612-18

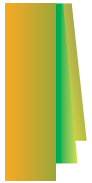

Dissecting and Ligature Forceps
Präparier- und Ligaturklemmen
Pinzas de disección y ligaduras
Pinze per preparazioni e legature



MC QUIGG-MIXTER
22.0 cm, 8¾"
RMC-1613-22

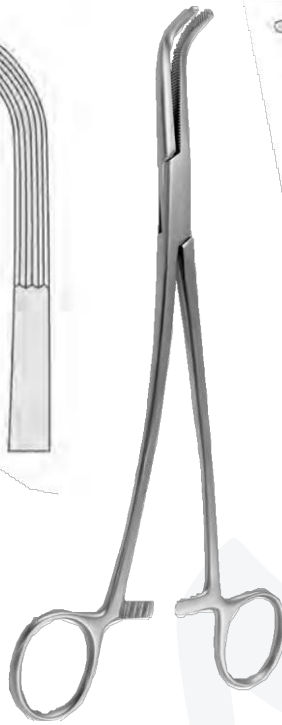

GRAY



22.0 cm, 8¾" RMC-1614-22 RMC-1615-22
23.0 cm, 9" RMC-1614-23 RMC-1615-23



CRAFOORD-SELLORS

HEAVILY-CVD

STRONGLY-CVD

SLIGHTLY-CVD

22.0 cm, 8¾"
RMC-1616-22

23.0 cm, 9"
RMC-1616-23

24.0 cm, 9½"
RMC-1616-24



FINOCCHIETTO
24.0 cm, 9½"
RMC-1617-24



Gall Duct and Kidney Pedicle Clamps
Gallenkanal- und Nierenstielklemmen
Pinzas-clamps para pedúnculo renal
Pinze per peduncoli renali



GUYON
20.0 cm, 8" RMC-1618-20
22.0 cm, 8½" RMC-1618-22
24.0 cm, 9½" RMC-1618-24



GUYON
23.0 cm, 9"
RMC-1619-23

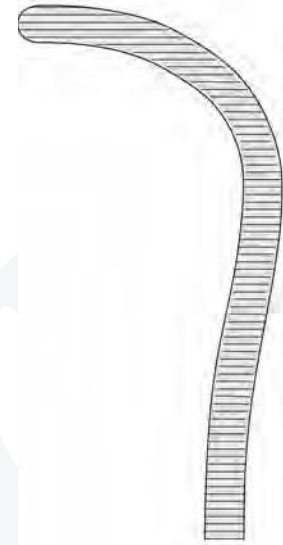

GUYON



23.0 cm, 9"
RMC-1620-23

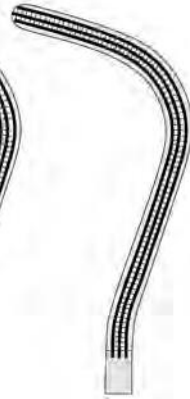

24.0 cm, 9½"
RMC-1621-24



STILLE
23.0 cm, 9"
RMC-1622-23

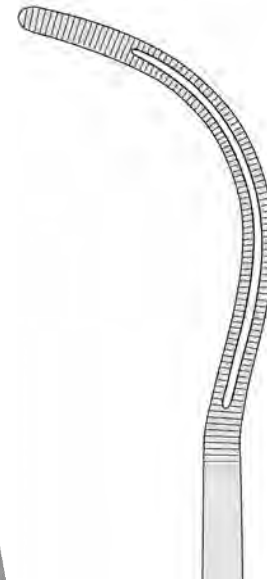

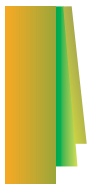

Gall Duct and Kidney Pedicle Clamps, Bronchus Forceps
Gallenkanal- und Nierenstielklemmen, Bronchusklemmen
Pinzas-clamps para pedúnculo renal, Pinzas-clamps para bronquios
Pinze per peduncoli renali, Pinze per legature



HERRICK
 23.0 cm, 9"
 RMC-1623-23

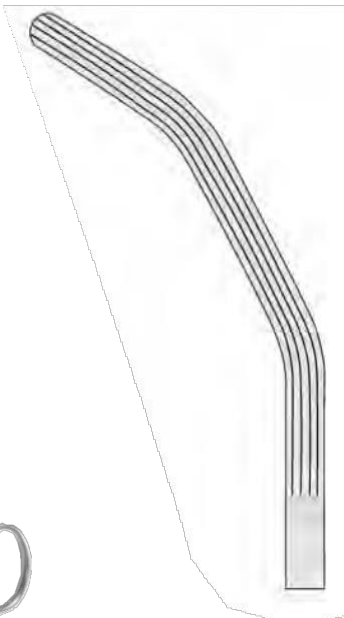

URO-TANGENTIAL
 18.0 cm, 7"
 RMC-1624-18

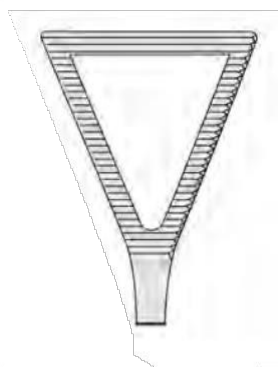

PRICE-THOMAS
 22.0 cm, 8³/₈"
 RMC-1625-22



LOVELACE
 20.0 cm, 8"
 RMC-1626-20

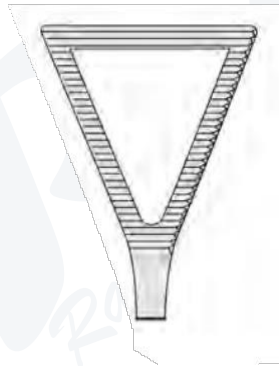

LOVELACE-ANGULAR
 20.0 cm, 8"



23.0 cm, 9"
 RMC-1627-23

24.0 cm, 9¹/₂"
 RMC-1627-24

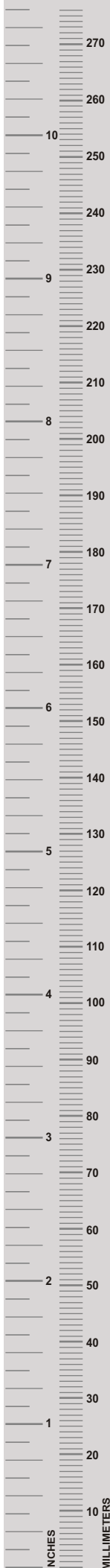



PRICE-THOMAS
 22.0 cm, 8¾"



LEFT-CVD
 RMC-1628-01

RIGHT-CVD
 RMC-1628-02



SEMB
 24.0 cm, 9½"

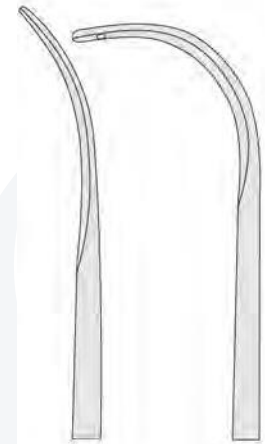

CVD
 RMC-1629-01

STRONGLY-CVD
 RMC-1629-02



BABY-MIKULICZ
 14.0 cm, 5½"
 RMC-1630-14



MIKULICZ
 18.0 cm, 7"
 RMC-1631-18



MIKULICZ
 20.0 cm, 8"
 RMC-1632-20

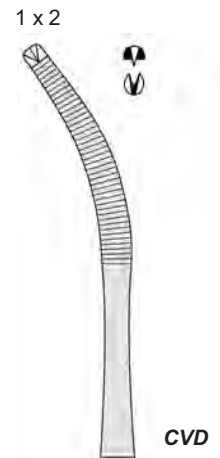

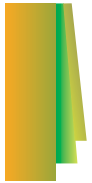

Peritoneum Forceps, Hysterectomy Forceps
Pinzas-clamps para peritoneo y para histerectomía
Pinze per peritoneo e per isterectomia
Peritoneumklemmen, Hysterektomieklemmen

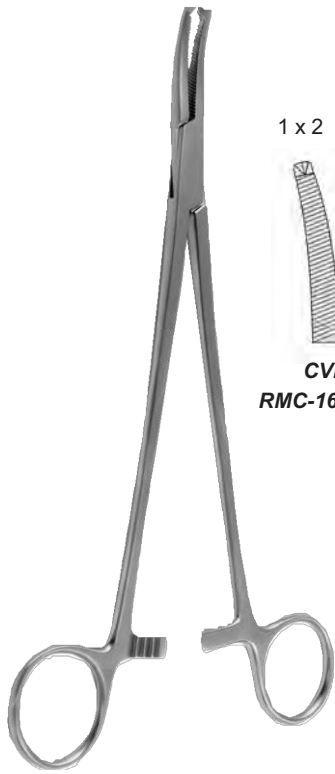

FAURE
20.0 cm, 8"

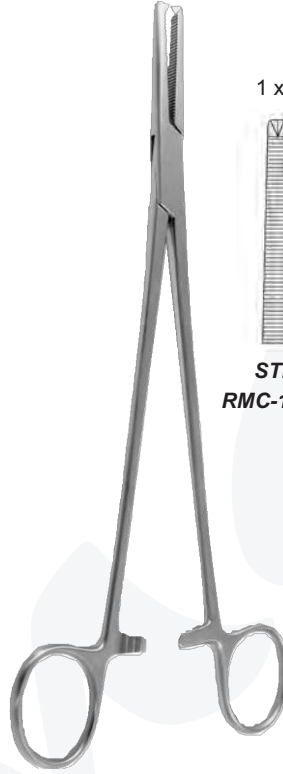
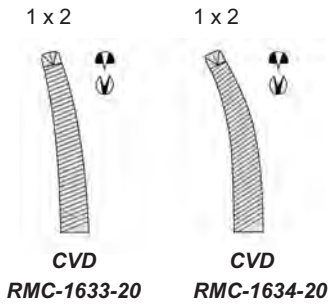

PHANEUF
21.5 cm, 8½"

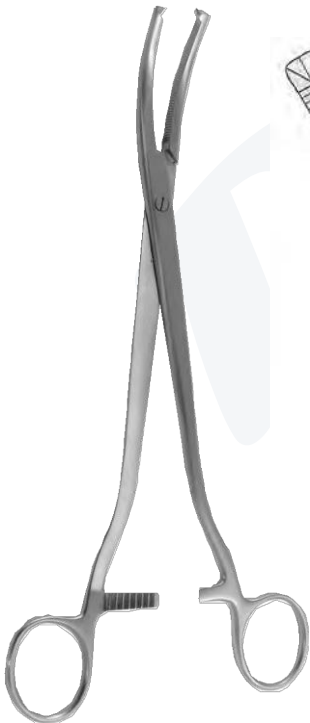
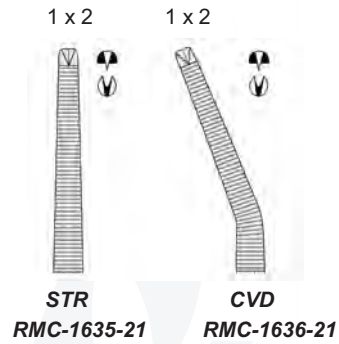

WERTHEIM
24.0 cm, 9½"
RMC-1637-20

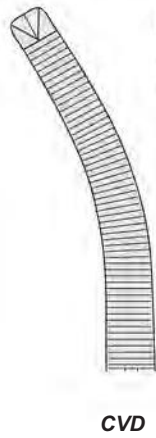

WERTHEIM
25.0 cm, 10"
RMC-1638-20

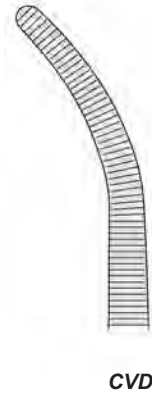

Hysterectomy Forceps
Hysterektomieklemmen
Pinzas-clamps para histerectomía
Pinze per isterectomia

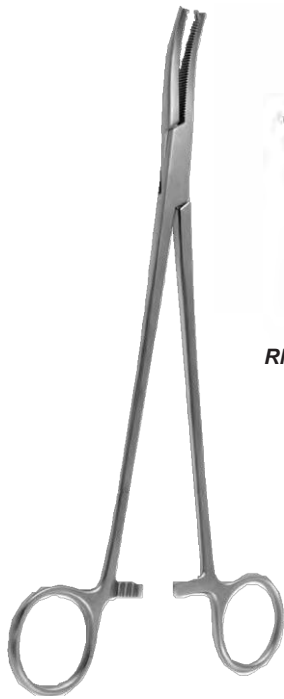

WERTHEIM
23.0 cm, 9"

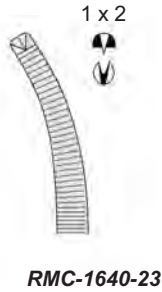
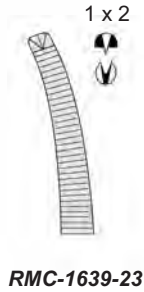

MAINGOT

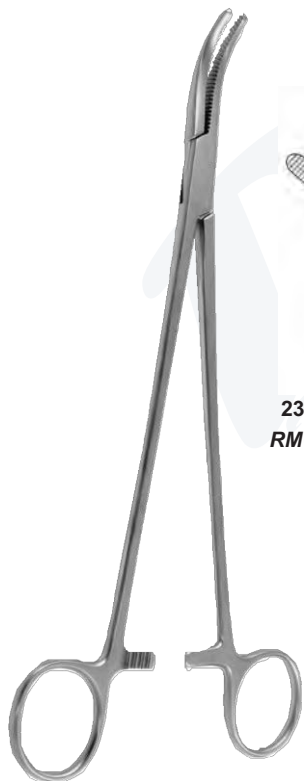

MOYNIHAN

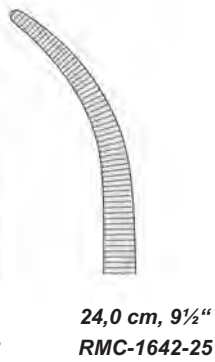

WERTHEIM-CULLEN
21.5 cm, 8½" **RMC-1643-21**

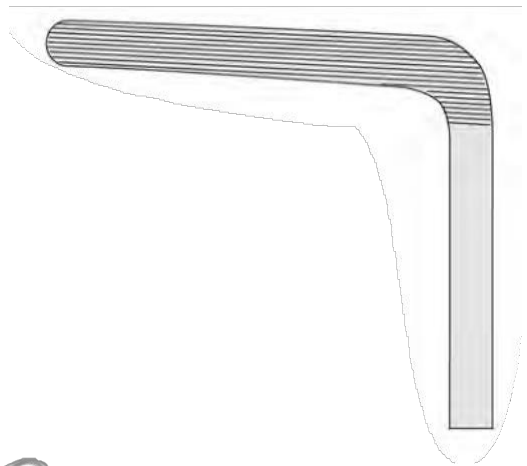

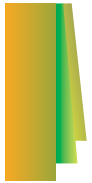

Hysterectomy Forceps
Hysterektomieklemmen
Pinzas-clamps para histerectomía
Pinze per isterectomia

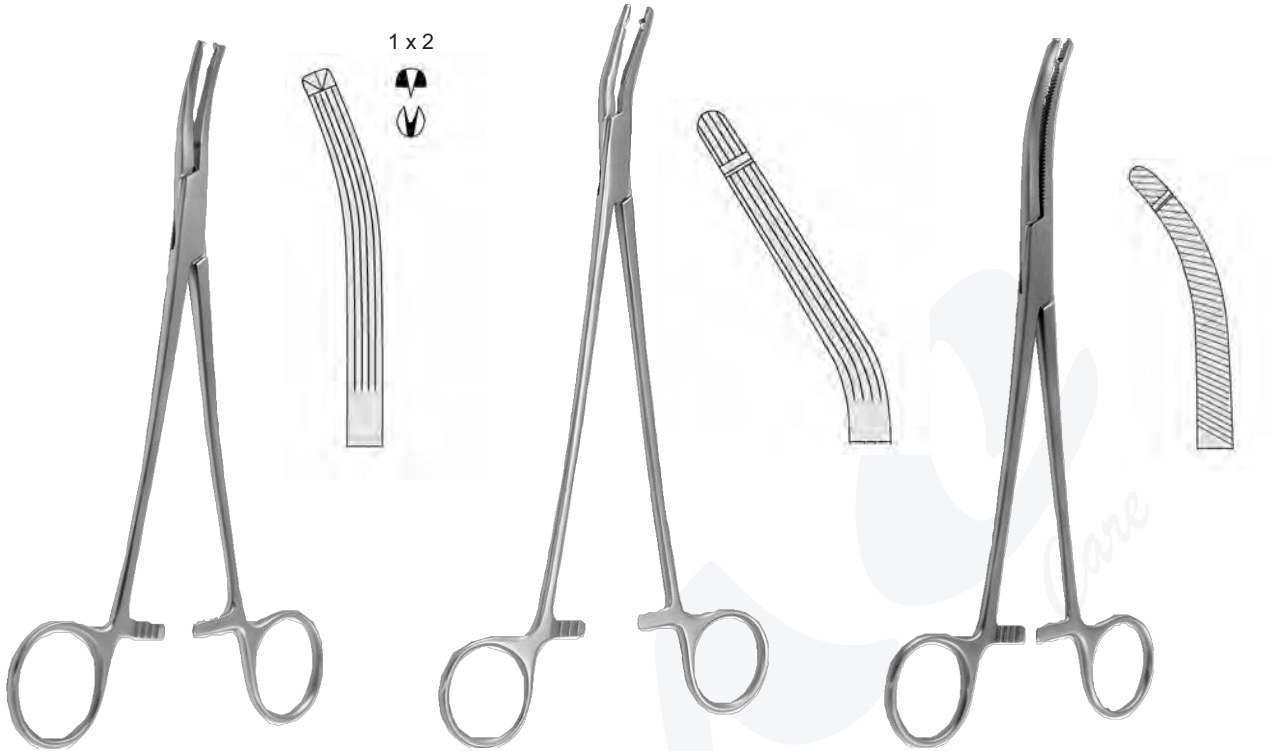

LONG
19.0 cm, 7 1/4"
RMC-1644-19

GARLAND
21.0 cm, 8 1/4"
RMC-1645-21

HEANEY
21.0 cm, 8 1/4"
RMC-1646-21

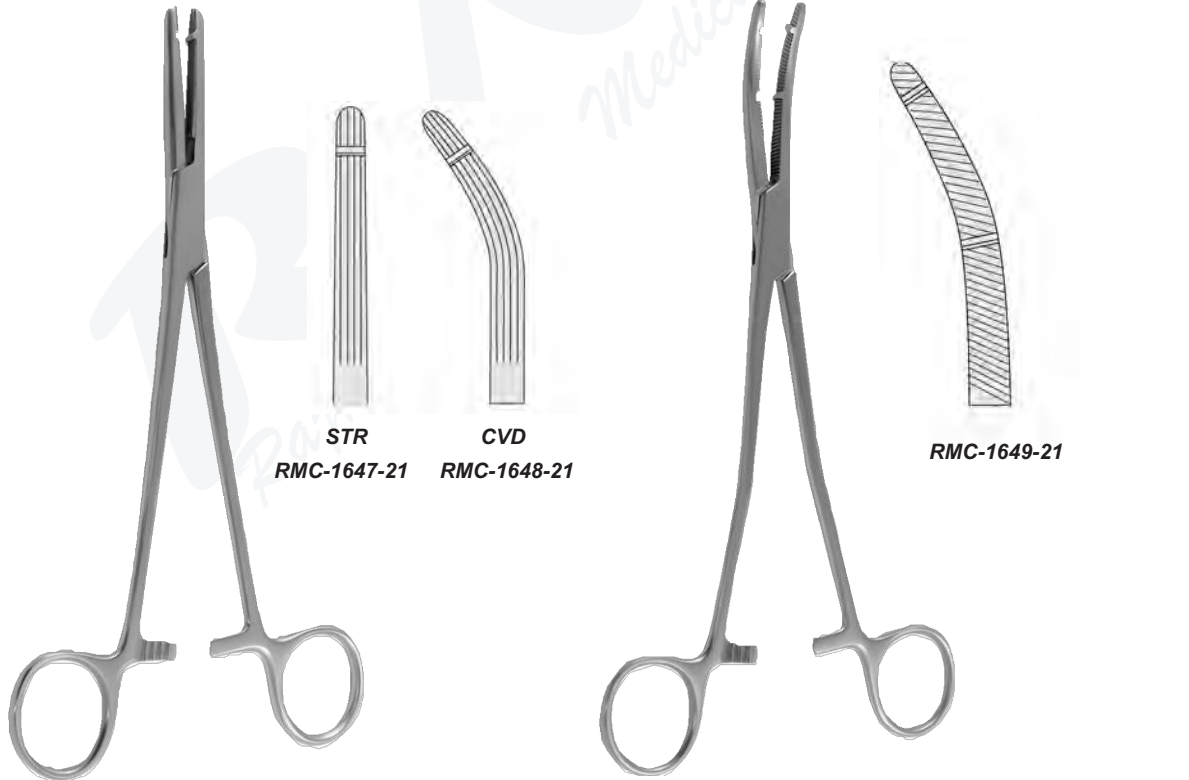

HEANEY-BALLANTINE
21.0 cm, 8 1/4"

HEANEY-KANTER
21.0 cm, 8 1/4"

STR
RMC-1647-21

CVD
RMC-1648-21

RMC-1649-21



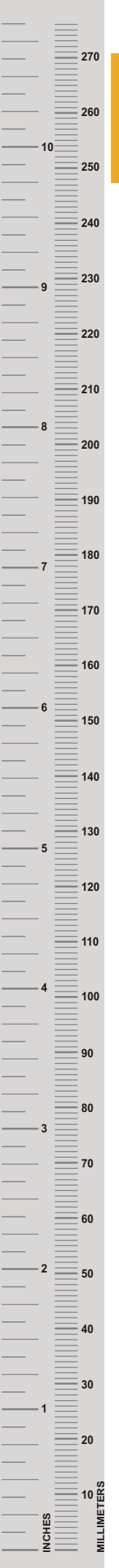

Hysterectomy Forceps
Hysterektomieklemmen
Pinzas-clamps para histerectomía
Pinze per isterectomia



HEANEY

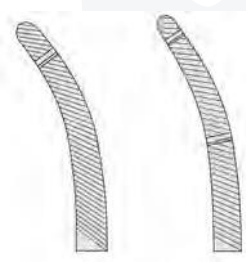

21.0 cm, 8 1/4" RMC-1650-21 RMC-1651-21
 23.0 cm, 9" RMC-1650-23 RMC-1651-23



FOLLOW US

rajpootmedicalcare